

# ASAR WIDE SWATH MODE INTERFEROMETRY: OPTIMISATION OF THE SCAN PATTERN SYNCHRONISATION

B. Rosich<sup>(1)</sup>, A. Monti-Guarnieri<sup>(2)</sup>, D. D'Aria<sup>(3)</sup>, I. Navas<sup>(4)</sup>, B. Duesmann<sup>(4)</sup>, C. Cafforio<sup>(5)</sup>, P. Guccione<sup>(5)</sup>,  
S. Vazzana<sup>(1)</sup>, O. Barois<sup>(1)</sup>, O. Colin<sup>(1)</sup>, E. Mathot<sup>(1)</sup>

<sup>(1)</sup>European Space Agency, ESA-ESRIN, Italy; E-mail: [brosich@esa.int](mailto:brosich@esa.int)

<sup>(2)</sup>Politecnico di Milano, Italy, E-mail: [monti@elet.polimi.it](mailto:monti@elet.polimi.it)

<sup>(3)</sup>ARESIS s.r.l., Italy, E-mail: [davide.daria@aresys.it](mailto:davide.daria@aresys.it)

<sup>(4)</sup>ESA-ESTEC, The Netherlands, E-mail: [ignacio.navas.traver@esa.int](mailto:ignacio.navas.traver@esa.int), [berthyl.duesmann@esa.int](mailto:berthyl.duesmann@esa.int)

<sup>(5)</sup>Politecnico di Bari, Italy, E-mail: [guccione@poliba.it](mailto:guccione@poliba.it)

## ABSTRACT

The availability of single look complex ENVISAT ScanSAR product (WSS) has opened new possibilities for interferometric applications requiring large scale analysis and short revisit time.

However, ScanSAR interferometry requires the scan pattern to be synchronized between interferometric acquisitions, which was not a design requirement for ENVISAT ASAR. Nevertheless, a preliminary analysis showed that the amount of sufficiently synchronized ASAR WSM data was much higher than expected. This is a consequence of the accurate ENVISAT orbit control and the systematic acquisition plan applied over certain areas of the world.

To further increase the percentage of WSM data with sufficient synchronization, the mission planning system has been slightly modified and WSM acquisitions are planned according to the new strategy since mid November 2006.

This paper presents the requirements for ASAR ScanSAR burst synchronization, the modifications introduced in the mission planning and the improvement in the synchronization percentage.

## 1. ASAR WIDE SWATH MODE

The ENVISAT Advanced Synthetic Aperture Radar (ASAR), one of the 10 instruments on board of ENVISAT, was designed to provide a large degree of operational flexibility, acquiring science data in 5 different modes. The Image Mode (IM) generates high spatial resolution data, in HH (H Transmit and H receive) or VV (V Transmit and V receive) polarization, over one of seven available swaths located over a range of incidence angles spanning 15° to 45°. The Alternating Polarisation (AP) Mode provides two simultaneous images from the same area in HH and VV polarizations, HH and HV or VV and VH, using the ScanSAR technique, with the

same imaging geometry as Image Mode and similarly high spatial resolution. The Wave Mode (WV) generates vignettes of 10 km by 10 km spaced 100 km along-track, in HH or VV polarisation. The Wide Swath Mode (WSM) and Global Monitoring Mode (GMM) are based on the ScanSAR technique using five sub-swaths (across track coverage of 400 Km) either in HH or in VV polarisation. The WSM is a high resolution mode, while the GMM is a low rate mode, which allows for a whole orbit operation at the cost of reducing the resolution to ~1Km. [R1]

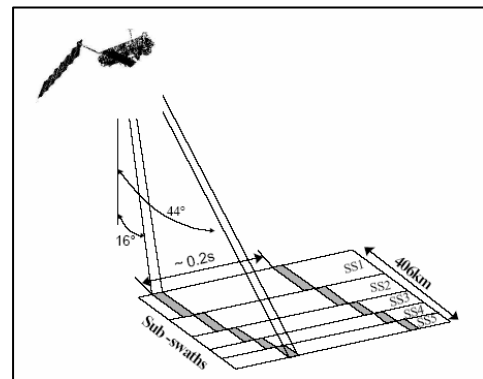

Figure. 1. ASAR Wide Swath geometry

The Wide-Swath Mode is a burst mode. The instrument illuminates a given sub-swath with a limited number of pulses before moving to the next sub-swath in the sequence. This contrasts with the continuous illumination of a swath in ASAR Image Mode. Thus, while in Image Mode, a given target will produce radar returns covering the full range of Doppler frequencies as the ASAR beam passes over it, in Wide-Swath Mode a target will only produce returns with Doppler frequencies corresponding to its range of geometries relative to the satellite during the burst period. The one-to-one angle-to-frequency correspondence of SAR ensures that different spectral portions of the target reflectivity are observed in the subsequent bursts (see Fig. 2). In ASAR WSM, each target is observed in three different bursts by different view angles.

## 2. THE ASAR WIDE SWATH SINGLE LOOK COMPLEX PRODUCT

Originally, the only operational Level-1 data product offered by ESA from ASAR Wide-Swath Mode (WSM) data was a ground-range multi-look detected product (ASA\_WSM\_1P), intended to support applications that exploit intensity data.

However, the possibility to perform interferometry between Image and Wide Swath mode and the interest in Wide Swath complex products for ocean applications encouraged the development of a wide swath single look complex (WSS) prototype product. A prototype WSS processor was developed for ESA by Politecnico di Milano and Politecnico di Bari and WSS products generated from this prototype were used to demonstrate not only the potential of IM-WS interferometry but also the possibility to perform WS-WS interferometry. Considering the high potential of the WS single Look Complex products, ESA decided to consolidate this new product and to integrate it in the ENVISAT Ground Segment. In particular, the ESA ASAR processor (PF-ASAR) was upgraded to include the processing of WSS products. The adopted WSS processing approach in PF-ASAR is the same as the prototype processor [R2] and consists in processing each burst and beam individually and to provide them separately within the product.

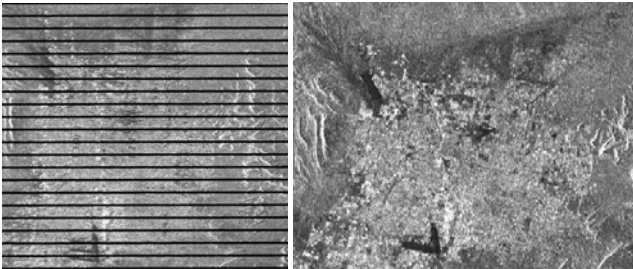

*Figure 2. Example of individual processed burst within one sub-swath as provided in the ASAR WSS products (left) and mosaicked burst to produce a standard detected image (right). It can be observed (left) that targets appear on 3 consecutive burst as a result of the 3 natural azimuth looks of ASAR WSM.*

The new ESA ASA\_WSS\_1P product is available as standard ENVISAT ASAR product since August 2005. It can be ordered using EOLI-SA (contact [ehelp@esa.int](mailto:ehelp@esa.int) for further details).

The ASA\_WSS\_1P product format is slightly different from other ASAR products since:

- there are 5 different Measurement Data Sets (MDS), one per sub-swath, each one containing a collection of processed burst;
- a “Doppler Grid” ADS to support ocean surface current applications has been introduced in the WSS products for the first time. It should be noticed however, that results using the Doppler Grid from WSS products have demonstrated the enormous potential of this information and the limitations of having the information available only within on-request products. Therefore, the Doppler grid has been recently included as well in the ground range detected multi-look WSM products, which are available on line systematically in NRT. See [R3] for more details.
- there are 5 records in the MPP ADS, one per sub-swath
- there are 5 records in the SQ ADS, one per sub-swath

Main features of the ASA\_WSS\_1P product are summarised below:

- Processing is fully phase preserving
- Data in the MDSs is sampled in a common grid both in range and in azimuth. In other words, WSS data is provided in a common sampling frequency in azimuth despite the fact that the PRF is different from sub-swath to sub-swath. This is an important convention adopted in the ASAR WSS processing to simplify the post-processing on the user side.
- Standard product is 60 sec long. This is currently the maximum possible length for WSS products.
- Azimuth pixel spacing has been set to 80 m. This is configurable and it was set to a value which could still provide an adequate sampling while limiting the product size (for 60 sec long product) to maximum of 2 GBytes. This was the maximum file size allowed in the original ENVISAT Ground Segment (GS). Finally, this limitation will soon be removed, and smaller azimuth sampling will therefore be possible.
- Auxiliary timeline information, providing the azimuth sensing start time for the first SS1 burst, has been added in the Main Processing Parameters ADS. This information has been included as well in standard WSM product and it is used to estimate the burst synchronisation percentage.
- Although the product is single-look complex, the elevation antenna pattern correction is applied by default to simplify the post-processing by the user.

A detailed description of the WSS product format can be found in the “ENVISAT-1 Product Format Specifications. Volume 4: ASAR Products Specifications” (PO-RS-MDA-2009, Is.4, Rev.A, 11/05/2004, [http://earth.esa.int/pub/ESA\\_DOC/ENVISAT/ASAR/ASAR\\_productspecs\\_issue4A.pdf](http://earth.esa.int/pub/ESA_DOC/ENVISAT/ASAR/ASAR_productspecs_issue4A.pdf)).

### 3. ASAR SCANSAR INTERFEROMETRY CONSTRAINTS

ASAR WS/WS interferometry, using pairs of acquisitions separated by  $N$  cycles (35 days = 501 orbits), imposes constraints on:

- the across-track baseline
- and
- the along-track scan pattern synchronisation [R2]

For a random scan (i.e. random planning), the following probabilities of burst overlap are expected:

30% overlap has probability of 20%

65% overlap has probability of 10%

The preliminary synchronisation results observed with ASAR were rather variable and they reached in some cases 80%, showing that the scan pattern was not fully random. The higher than expected synchronisation percentages can be explained by:

- the fact that many WS acquisitions were planned systematically (background mission planning), with similar or same start times.
- the excellent orbit accuracy (along-track differences between restituted and predicted orbits better than 10 ms).
- the final planning accuracy, since the planning is based on the reference orbit but the scheduled times are adjusted using the predicted orbit before up-linking the commands, with an accuracy better than 10  $\mu$ s in along-track.
- the very stable instrument commanding delay (from the execution of the mode switching command to the time the first pulse is transmitted). The spread of this delay is approximately 4 ms with Rayleigh distribution.

The baseline constraint was found to be in some cases more limiting than the burst synchronisation constraint.

In order to reduce the orbit baselines, the strategy for orbit control has been slightly modified recently and baselines for ASAR interferometric pairs acquired after 23<sup>rd</sup> January 2007 will be significantly reduced as described in [R4].

### 4. ASAR SCANSAR INTERFEROMETRIC EXAMPLES

One of the key aspects of ScanSAR interferometry is the large ScanSAR coverage. Some examples of ScanSAR interferometry, showing the benefit of large coverage for tectonic applications are provided below.

Many ASAR ScanSAR interferometric results have been obtained so far. Fig. 3 shows an example of ASAR WS/WS interferogram over Bam with a burst overlap of about 90% and Fig. 4 shows an example of a result over Ethiopia where the burst overlap is about 65%.

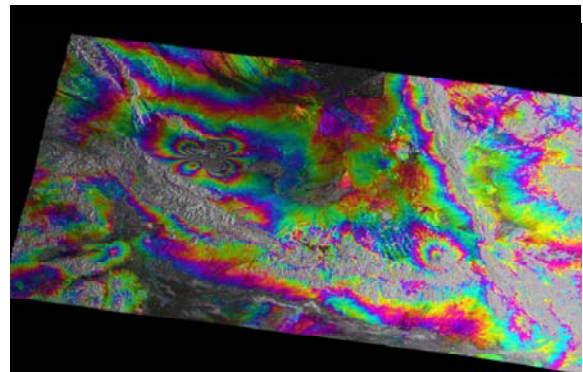

Figure.3. Bam Earthquake, 04/02/03- 08/06/04 (490 days), Baseline: ~ 245m, Overlap: ~90-98%

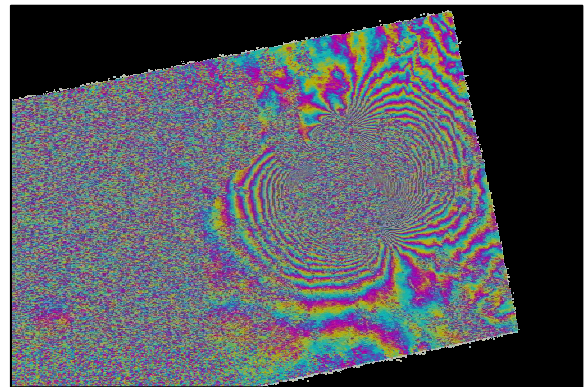

Figure.4. Ethiopia Earthquake, June 2005- December 2005, Baseline: ~ 452, Overlap: ~66%

## 5. ASAR WS/WS SYNCHRONISATION REQUIREMENTS

In ScanSAR mode, bursts of 50-71 echoes are acquired cyclically (in the following order: SS1, SS3, SS5, SS2, SS4) out of each sub-swath, getting coverage for a strip that is 400 km wide on the ground (range). The precise timeline for each sub-swath is provided in Table 1.

beam	Number pulses per burst	rank
SS1	50	9
SS2	65	12
SS3	55	10
SS4	71	13
SS5	60	11

Table 1 . WSM current timeline.

Based on the above timeline and on the timing parameters for each sub-swath, the cycle time is provided in Table 2.

Table 2 shows as well that there are two different PRF values per sub-swath, which are used in well-defined orbit segments and which result in different cycle times. The first PRF value is used from the ascending node (ANX = 0 sec) to 3825 sec from ANX and also from 5190 sec from ANX to ANX crossing time. The second value is used for a smaller segment, from 3480 sec from ANX to 5550 sec from ANX. It can be seen that there is some overlap between both segments, which provides some flexibility for changing the PRF depending on the acquisition segment length.

ANX start [sec]	ANX stop [sec]	beam	PRF [Hz]	Burst duration [msec]	Rank duration [msec]	Burst (& Rank) duration [msec]	cycle duration [sec]
0	3825	SS1	1684.884	29.7	5.3	35.02	0.1920
		SS2	2102.417	30.9	5.7	36.62	
		SS3	1692.605	32.5	5.9	38.40	
		SS4	2080.555	34.1	6.2	40.37	
		SS5	1707.046	35.1	6.4	41.59	
3480	5550	SS1	1666.755	30.0	5.4	35.40	0.1942
		SS2	2078.753	31.3	5.8	37.04	
		SS3	1674.31	32.8	6.0	38.82	
		SS4	2056.497	34.5	6.3	40.85	
		SS5	1688.439	35.5	6.5	42.05	
5190	6045	SS1	1684.884	29.7	5.3	35.02	0.1920
		SS2	2102.417	30.9	5.7	36.62	
		SS3	1692.605	32.5	5.9	38.40	
		SS4	2080.555	34.1	6.2	40.37	
		SS5	1707.046	35.1	6.4	41.59	

Table 2 . WSM timing parameters and cycle duration.

A burst overlap better than 50% for the shortest burst length is required to guarantee sufficient common azimuth bandwidth between WS interferometric pairs. Based on Table 2, this corresponds to a maximum time difference in the scan pattern synchronisation between two interferometric acquisitions of 14.84 ms..

## 6. OPTIMISATION OF THE ASAR WS SCAN PATTERN SYNCHRONISATION

### 6.1 Assessment of ASAR timing events accuracy

Considering that the end-to-end timing precision required to ensure sufficient scan pattern synchronisation is 14.84 ms, it is necessary to analyse the accuracy of the different timing events involved in the ASAR planning to evaluate the feasibility of optimising the WS scan pattern synchronisation.

ASAR planning is initially based on a reference (theoretical) orbit to set up the requested start times. Well-defined planning margins are added to these times as appropriate to count for transition times and processing margins.

Before the uplink of the acquisition commands, the segment start times are updated from those based on the reference (theoretical orbit) to those based on the predicted orbit, using the nearest location across & along track. The accuracy of this time change is better than 35  $\mu$ s. The predicted orbit accuracy is known to be better than 10 ms. And finally, the ASAR instrument commanding execution time is very stable, with an accuracy better than 4 ms with Rayleigh distribution (most events well below the 4 ms with some above).

It can therefore be concluded that the actual accuracy of the several timing events is slightly better than the one required for ensuring at least 50% of burst overlap.

### 6.2 Way forward for the optimisation of the ASAR WS scan pattern synchronisation

The analysis of the different factors contributing to the higher than expected burst synchronisation has indicated that this could be optimised with small changes in the planning strategy. After reviewing the preliminary synchronisation results for a limited number of data sets and the different factors contributing to the higher than expected burst synchronisation, it became obvious that a change in the planning strategy could significantly improve the probability of synchronisation between WS interferometric pairs.

The ASAR planning has been modified to include a “discrete grid of possible start times around the orbit”, separated by the ScanSAR cycle time (i.e. 0.19 sec), starting at the ascending node crossing time. The start time of planned ASAR WS mode segments ASAR WS was then shifted backwards to the closest grid point (Fig.5). This means that requested ASAR WS start times are systematically anticipated by less than 0.19 sec and that any WS



segment will be planned to start on one of the grid points. The planned start time will therefore be modified as described before by the several timing events, but the accuracy will remain better than the 14.84 ms.

It should be recalled that ASAR uses two different sets of Pulse Repetition Frequencies (PRF) depending on the latitude resulting in two WS cycle durations. Therefore two different grids were defined and only acquisitions that use the same grid are expected to have sufficient burst overlap.

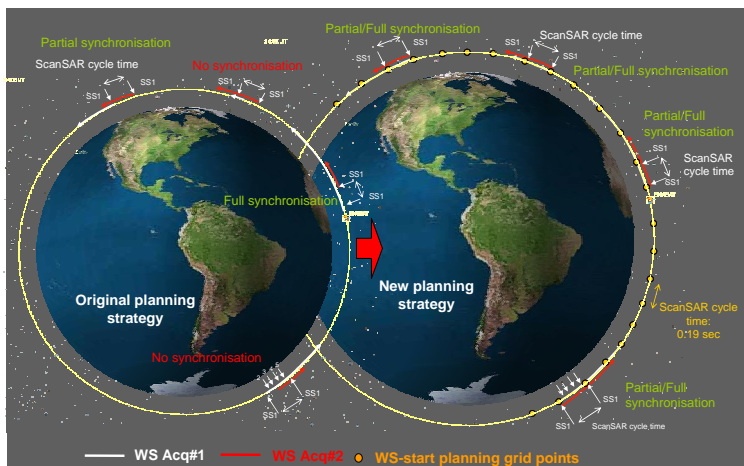

Figure 5. Illustration of the original and the new ASAR WS planning strategy.

The new planning strategy is operational since 17 September 2006 (orbit 23783).

## 7. ASSESSMENT OF THE IMPROVEMENT OF THE SCAN PATTERN SYNCHRONISATION AFTER THE PLANNING OPTIMISATION

In order to assess the synchronisation improvement after the ASAR planning changes, two sets of WS data sets have been analysed:

- Data set 1 (before the optimisation):
  - WSM data acquired from Jan-2006 to Sep-2006
  - 8158 WSM products
  - 4308 candidates
- Data set 2 (after the optimisation):
  - WSM data acquired from Oct-2006 to Dec-2006
  - 5264 WSM products
  - 1447 candidates

Fig.6. shows the statistics of burst synchronisation percentage for both data sets (it should be noticed that 9 months of data are used for the analysis before the optimisation while only 3 months of data are used afterwards).

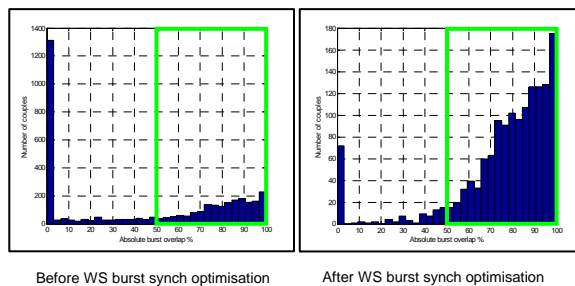

Figure 6. Statistics of burst synchronisation for data before and after the planning changes.

Fig. 7. shows the probability of burst overlap (for overlap values better than 0%) for both data set populations.

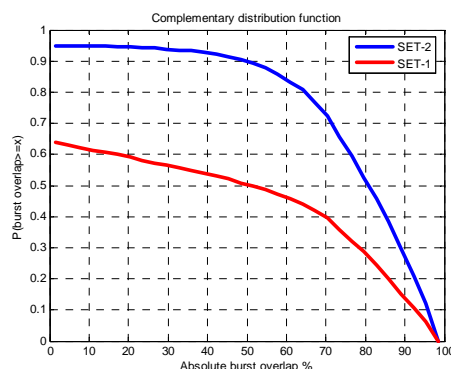

Figure 7. Comparison of burst synchronisation probability before and after the planning changes.

As it can be observed, the probability of having overlaps better than 70% has basically been doubled. In particular:

- the probability of having more than 50% burst overlap has increased from 50% to 90%.
- the probability of having more than 80% burst overlap has increased from 30% to 50%.

## 8. AVAILABILITY OF ASAR WS BURST SYNCHRONISATION INFORMATION TO THE USERS

The WS burst synchronisation estimation is mainly based on:

- 1) The precise orbit information (DORIS preliminary or precise orbit information can be used)
- 2) The precise acquisition start time (a timeline reference point, usually the first burst of SS1 time is considered).

The first information is extracted from the DORIS orbit files. The second one is available in ASAR WSM products, which are processed systematically and made available on line in NRT.

Required timing information is therefore extracted from processed WSM products using the GRID infrastructure at ESRIN. This timing information is then input to the burst synchronisation estimation system, where it is used to derive the synchronisation percentage between any WSM acquired segment and a “theoretical reference”. This information is stored in a database. A simple web-based query tool has been implemented to search for available WS interferometric pairs and the synchronisation between a given pair is computed on the fly for a given query.

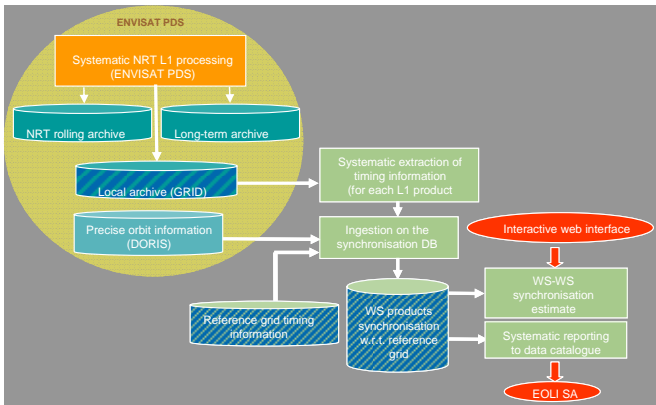

Figure 8. High level illustration of the end-to-end burst synchronisation estimation system.

The interactive query interface can be accessed at: [http://earth.esa.int/pcs/envisat/asar/wss\\_sync/](http://earth.esa.int/pcs/envisat/asar/wss_sync/)



Figure 9. Interactive query interface snapshot.

The burst synchronisation information is also available in EOLI SA since v5.2 (<http://eoli.esa.int/geteolisa/index.html>). From this version onwards, interferometric queries in EOLI SA, using local inventory, will provide not only the baseline information but also the burst synchronisation percentage.

## 9. CONCLUSIONS

The feasibility of WSM/WSM and WSM/IM interferometric combinations has now been largely proven. ESA offers ASAR WS single look complex products (WSS) since August 2005. ASAR WS/WS interferometric results indicated a synchronisation probability higher than expected. After analysis of the different factors contributing to the scan pattern synchronisation, the

ASAR WS mode planning strategy was modified on 17<sup>th</sup> September 2006 to optimise the probability of sufficient burst overlap between WS interferometric pairs.

The results, based on 3 months of data acquired using the new strategy are extremely positive. The probability of having more than 50% burst overlap has increased from 50% to 90%.

It should be stressed that although ASAR Wide Swath Mode was not designed to be burst-synchronous, significantly high probability of sufficient burst overlap has been achieved with no changes at instrument level, but only exploiting the excellent end-to-end timing accuracy of the system and by introducing a minor change in the ASAR planning strategy.

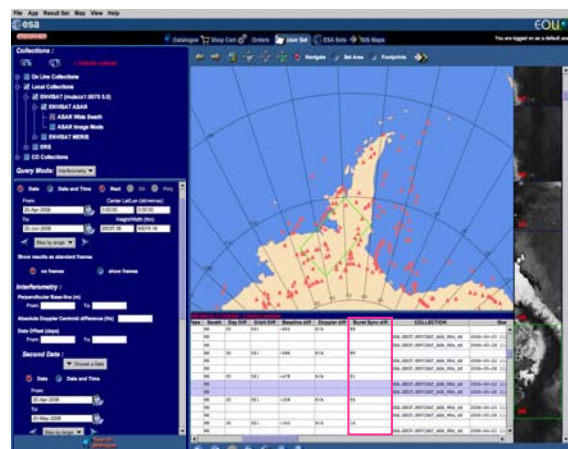

Figure 10. Snapshot of the EOLI SA ScanSAR interferometric query result

## REFERENCES

- [1] B. Rosich, R. Torres. I. Navas, A. Monti-Guarnieri, P. Meadows, *ASAR Calibration Performance: A Review After Four Years of Operation*, EUSAR 2006.
- [2] P. Guccione et al., *The ASAR Wide Swath Single Look Complex product: properties and applications*, ENVISAT Symposium 2004
- [3] B. Rosich et al., *ASAR Instrument Performance and Product quality evolution*, ENVISAT Symposium 2007
- [4] B. Duesmann et al., *Optimising ENVISAT ASAR interferometry opportunities by orbit maintenance*, ENVISAT Symposium 2007.