

MI.03

"Made available under NASA sponsorship  
in the interest of early and wide dis-  
semination of Earth Resources Survey  
Program information and without liability  
for any use made thereof."

E83-10226 835-D-404

Tim. 85245 Sep

# LANDSAT-4 MULTISPECTRAL SCANNER (MSS) SUBSYSTEM RADIOMETRIC CHARACTERIZATION

(E83-10226) LANDSAT-4 MULTISPECTRAL SCANNER  
(MSS) SUBSYSTEM RADIOMETRIC CHARACTERIZATION  
(NASA) 77 p HC A05/BF A01 CSCL 14B

83-21467

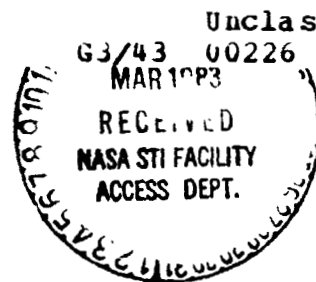

FEBRUARY 1983

ORIGINAL PAGE IS  
OF POOR QUALITY



**NASA**  
National Aeronautics and  
Space Administration

**GODDARD SPACE FLIGHT CENTER**  
GREENBELT, MARYLAND

435-D-404

**LANDSAT-4 MULTISPECTRAL SCANNER (MSS) SUBSYSTEM  
RADIOMETRIC CHARACTERIZATION**

**Editors**

**W. Alford and J. Barker  
NASA/Goddard Space Flight Center  
Greenbelt, Maryland**

**Prepared by**

**B. P. Clark and R. Dasgupta  
Computer Sciences Corporation  
8728 Colesville Road  
Silver Spring, Maryland**

**February 1983**

**GODDARD SPACE FLIGHT CENTER  
Greenbelt, Maryland**

## FOREWORD

The authors wish to acknowledge the support received from both government and contract personnel associated with the Landsat-4 program. Constructive discussions and useful data have been provided by both W. Webb and J. Bala of the National Aeronautics and Space Administration (NASA). Outside contractor support was provided by L. Beuhler from Operations Research, Incorporated, and by J. Dietz and P. Mallerbe from the General Electric Corporation.

Many general references to the Landsat program are available to the public. Relevant information and data from these references have been extracted for incorporation into this document. It is hoped that this will broaden the circulation of critical information carried in these documents. Of particular interest are four publications, two by the Hughes Aircraft Company and two by the General Electric Corporation. The titles of these documents are (1) "Multispectral Scanner, Final Report," HS-248-0010-0867, Hughes Aircraft Company (March 1982); (2) "MSS Protoflight Radiometric Calibration and Alignment Handbook," HS-248-1379, Hughes Aircraft Company (July 1981); (3) "Landsat-D MSS Baseline Test Procedure," ITP-LD-311, General Electric Corporation (September 1981); and (4) "MSS Standard Interface Document," GE-B0-78-034, General Electric Corporation (July 1978).

These documents contain explicit information pertaining to sensor and spacecraft level tests and their results. In addition, the document "Landsat-4 to Ground Station Interface Description," Revision 5, GSFC 435-D-400 (August 1982), has been referenced where appropriate. Data and other technical memoranda accessed include both NASA publications and presentation material used in May 1982 at the first Landsat-4 users' conference.

PRECEDING PAGE BLANK NOT FILMED

## CONTENTS

<u>Section</u>	<u>Page</u>
FOREWORD . . . . .	iii
1. INTRODUCTION . . . . .	1-1
1.1 Overview . . . . .	1-1
1.2 Document Organization . . . . .	1-3
2. LANDSAT-4 MSS SYSTEM DESCRIPTION . . . . .	2-1
2.1 Scanner Optics for MSS . . . . .	2-1
2.2 Detectors and Electronics . . . . .	2-3
2.3 Scanner Optics Operation . . . . .	2-3
2.4 Mission Acquisitions . . . . .	2-5
2.5 Comparison of Landsat 4 with Previous Landsats . . . . .	2-7
2.6 Comparison of Unit Test Data with GE Thermal Vacuum Data . . . . .	2-7
3. MSS SPECTRAL CHARACTERIZATION . . . . .	3-1
3.1 Objective . . . . .	3-1
3.2 Procedure . . . . .	3-2
3.3 Results . . . . .	3-2
3.4 Comparison with Previous Landsats . . . . .	3-2
3.5 Conclusions . . . . .	3-10
4. PRELAUNCH MSS SENSOR RADIOMETRIC CHARACTERIZATION . . . . .	4-1
4.1 Introduction . . . . .	4-1
4.2 Calibration Procedure . . . . .	4-4
5. POSTLAUNCH MSS RADIOMETRIC PROCESSING . . . . .	5-1
5.1 Introduction . . . . .	5-1
5.2 Radiometric Corrections . . . . .	5-3
5.2.1 Radiometric Correction Using Calibration Wedge Data . . . . .	5-3
5.2.2 Radiometric Correction Using Scene Content . . . . .	5-4
5.3 Detector Gain and Offset Update . . . . .	5-8
5.4 $R_{max}$ and $R_{min}$ Update . . . . .	5-11
6. LANDSAT-4 IMAGE PROCESSING DATA . . . . .	6-1
6.1 Image Processing Parameter Files . . . . .	6-1
6.2 Short-Term Parameter File . . . . .	6-1
6.3 Calibration Modifiers . . . . .	6-3
6.4 Long-Term Parameter File . . . . .	6-5

## ILLUSTRATIONS

<u>Figure</u>		<u>Page</u>
2-1	Schematic Diagram of MSS Optics .....	2-2
2-2	MSS Data Acquisition.....	2-4
2-3	Perspective of MSS Data Acquisition.....	2-6
2-4	Landsat-4 Orbit Characteristics.....	2-8
3-1	Relative Spectral Response for an MSS Sensor .....	3-3
4-1	Systematic MSS Video and Wedge Level Timing Sequence .....	4-2
4-2	Hysteresis Effects on Detector Readings.....	4-3
4-3	Spectral Radiant Emittance Plot for 76-cm Integrating Sphere.....	4-6
4-4	Illustrative MSS Lamp Calibration Wedge .....	4-7
4-5	Band Normalization of MSS Channel Gains and Offset.....	4-11
5-1	Flow Diagram for Postlaunch Radiometric Calibration.....	5-2
5-2	Flow Diagram of Scene Content Correction Processing.....	5-7
5-3	Scene Segment Blending .....	5-9

## TABLES

<u>Table</u>		<u>Page</u>
2-1	MSS Differences for Landsat 3 and Landsat 4.....	2-9
3-1	MSS Optical Filter Specification.....	3-4
3-2	Spectral Characterization by Channel for the Landsat-4 MSS.....	3-5
3-3	Characterization of Landsat-4 MSS (Band 1) and Comparison with Landsats 1, 2, and 3 .....	3-6
3-4	Characterization of Landsat-4 MSS (Band 2) and Comparison with Landsats 1, 2, and 3 .....	3-7

## TABLES (Continued)

<u>Table</u>	<u>Page</u>	
3-5	Characterization of Landsat-4 MSS (Band 3) and Comparison with Landsats 1, 2, and 3 . . . . .	3-8
3-6	Characterization of Landsat-4 MSS (Band 4) and Comparison with Landsats 1, 2, and 3 . . . . .	3-9
6-1	Calibration Nominal Values Used in Each Mode of Sensor Operation . . . . .	6-2
6-2	Multiplicative Modifiers (M) and Additive Modifiers (A) Currently Used in MIPS. . . . .	6-4
6-3	MIPS Parameters Record. . . . .	6-6
6-4	Additional MIPS Parameters . . . . .	6-9
6-5	Decompression Tables for Bands 1, 2, and 3 . . . . .	6-10
6-6	Decompressed Digital Values. . . . .	6-11
6-7	Calibration Coefficients for High-Gain, Prime Lamp . . . . .	6-13
6-8	Calibration Coefficients for Low-Gain, Primary Lamp . . . . .	6-15
6-9	Calibration Coefficients for High-Gain, Redundant Lamp. . . . .	6-16
6-10	Calibration Coefficients for Low-Gain, Redundant Lamp. . . . .	6-17
6-11	Calibration Wedge Offsets for the Prime Lamp . . . . .	6-18
6-12	Calibration Wedge Offsets for the Redundant Lamp . . . . .	6-19
6-13	Geometric Image Tic-Mark and Annotation Parameters Carried in the Long-Term Record . . . . .	6-20

# SECTION 1

## INTRODUCTION

### 1.1 OVERVIEW

The purpose of this document is to describe the radiometric calibration procedures for the Landsat-4 Multispectral Scanner (MSS) subsystem. The topics covered are as follows:

- Instrument Description
- MSS Spectral Characterization
- Prelaunch MSS Radiometric Calibration
- Postlaunch MSS Radiometric Processing
- Examples of Current Data Resident on the MSS Image Processing System (MIPS)

The objective of the radiometric calibration is to relate video digital levels on computer compatible tapes (CCT's) to radiance into the sensor. To achieve this, the sensor must be calibrated with respect to a radiance source. The scanner subsystem includes such an internal radiance source (lamps).

The basic function of the internal calibration system is to provide repetitive sets of voltages (digital counts) for each detector for known input radiance levels. The digital values and their corresponding radiance levels are assumed to be related through a linear equation.

The radiance levels of the internal source are established by calibrating it with respect to known standard reference levels. Such a source is provided by the NASA 76-cm (30-inch) integrating sphere. During prelaunch calibration, the MSS is used as a transfer device between the integrating sphere and the internal lamp. The known radiance values from the integrating sphere and their corresponding digital counts for the detector outputs are used to establish each detector's linear transformation. This transformation is used in a subsequent step to obtain the radiance levels of the internal lamp.

The MSS instrument has six detectors for each band. The detectors for any given band may have different responses to different input radiances. Some detectors saturate at different input radiance

levels; others can register zero digital values corresponding to different low-input radiances. This causes striping in the MSS image. It is therefore necessary to map the responses of all six detectors of a given band to a common calibration curve. This results in one single straight line in the radiance-digital count plane for each band as shown below:

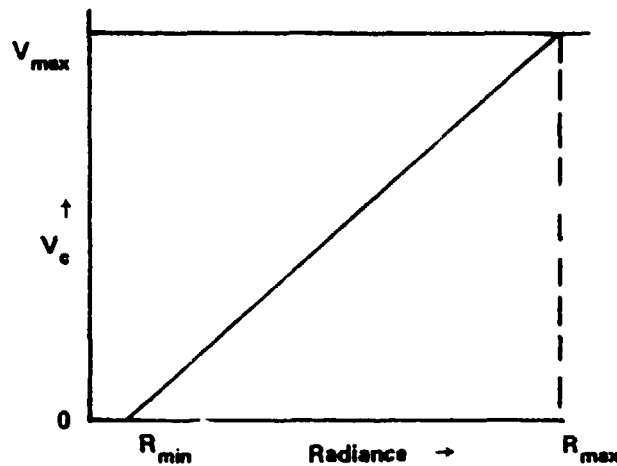

The radiance value corresponding to a digital count  $V_c$  (on the CCT) resulting from the above straight line relationship is given by

$$R = V_c \frac{R_{max} - R_{min}}{V_{max}} + R_{min} \quad (1-1)$$

where  $R_{max}$  is the saturation radiance that results in maximum digital count  $V_{max}$  (typically = 127) and  $R_{min}$  is the lower cutoff radiance resulting in zero digital value. For Landsat 4, the most current values of  $R_{max}$  and  $R_{min}$  are given as follows:

<u>Band</u>	<u><math>R_{min}</math> (mW/cm<sup>2</sup>/sr)</u>	<u><math>R_{max}</math> (mW/cm<sup>2</sup>/sr)</u>
1	0.02	2.3
2	0.04	1.8
3	0.04	1.3
4	0.10	4.0



During prelaunch calibration analysis, linear regression coefficients are derived that relate the gain and offset of a detector to radiance levels of the internal lamp. These coefficients are used during postlaunch radiometric processing. Using these coefficients and data collected from the internal lamp during flight operation (often in conjunction with scene content data), digital counts versus radiance curves for each detector are once again generated. The final result is a Radiometric Lookup Table (RLUT) that allows a radiance value to be assigned to each detector reading. In addition, all detectors of a given band are again mapped to a common calibration curve, and a new equation identical with equation (1-1) is obtained with new values of  $R_{max}$  and  $R_{min}$ .

## **1.2 DOCUMENT ORGANIZATION**

Section 2 describes the MSS instrument, and Section 3 summarizes the spectral characteristics of the MSS. Section 4 introduces the reader to the prelaunch calibration procedures. Section 5 discusses postlaunch radiometric processing. Section 6 presents examples of current data resident on MIPS.

## SECTION 2

### LANDSAT-4 MSS SYSTEM DESCRIPTION

The MSS is familiar to most users of remotely sensed, digitally processed image data. The following instrument description will illustrate the scanner optics configuration, the electro-optics configuration, and major performance issues relevant to the Landsat-4 MSS.

The MSS is a scanner optic system capable of generating Earth imagery in four spectral bands. Data are gathered by either phototubes or photodiodes, multiplexed, and then transmitted to an Earth station. Images generated cover 185 km on a side. The ground-processing system artificially frames these data by using the world reference system set of scene centers established by NASA.

#### 2.1 SCANNER OPTICS FOR MSS

The scanner optic system is specially designed to ensure contiguous coverage for each band of imagery. Data are acquired when sunlight reflected from the Earth's surface impinges on an oscillating flat mirror that redirects the Earth image into a Ritchey-Chretien-type Cassegrainian telescope, as shown in Figure 2-1. The mirror oscillation sweeps the Earth image across the focal plane of the telescope, at which point a fiber optic bundle receives the light and transmits data for each sensor to its respective phototube or photodiode. Bands 1, 2, and 3 each use six matched phototubes for detection; band 4 consists of six matched silicon photodiodes.

The fiber optic bundle is preceded by a rotating shutter wheel that allows image data to pass into the sensor array during the west-to-east ground track scan direction. Otherwise, the image data are obscured. During retrace motion of alternate scans, light from a calibration lamp impinges on the sensor system.

Light from the calibration lamp passes through a graded density filter before receipt by the focal plane fiber optic array. During ground processing, six unique calibration wedge data words are used to extract digital calibration light levels for each of the 24 sensors. The timing sequence between

ORIGINAL PAGE IS  
OF POOR QUALITY

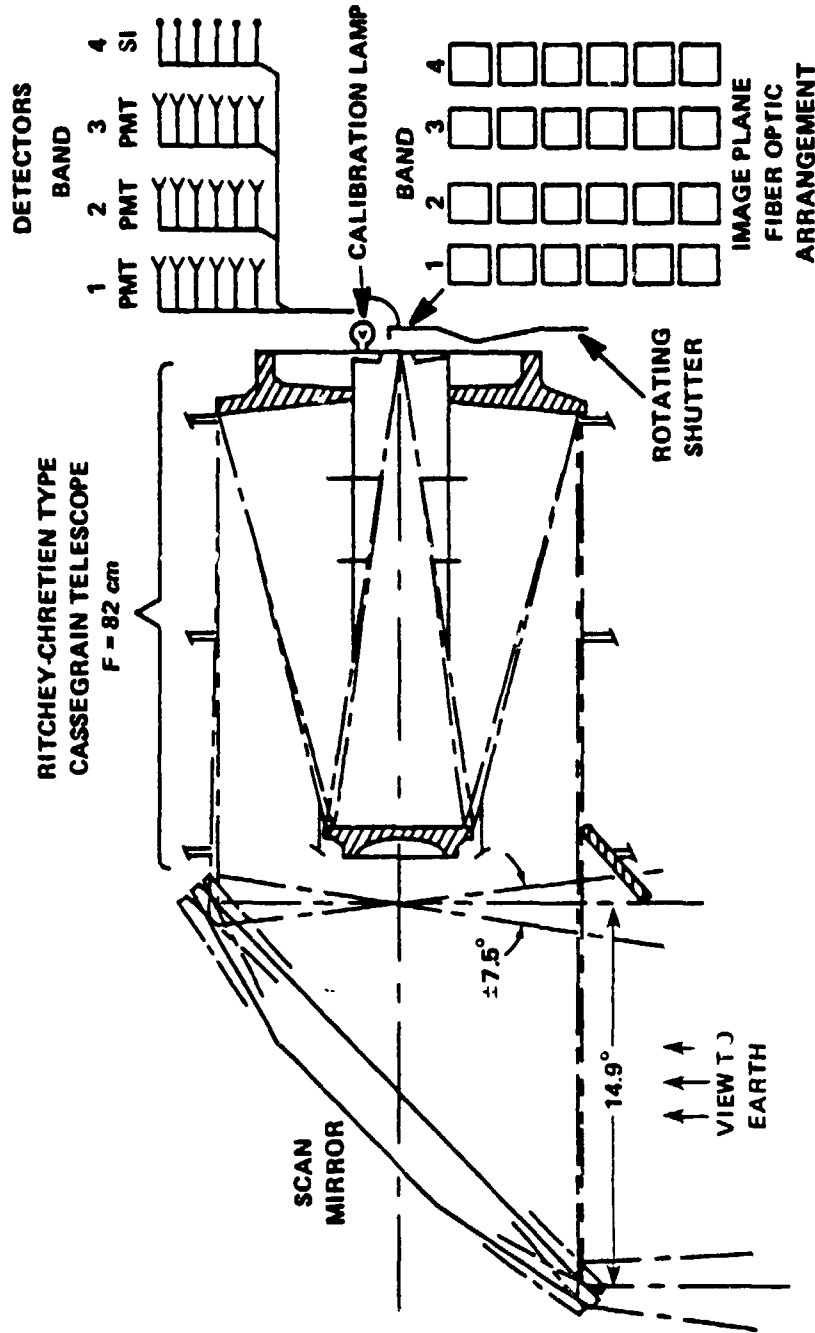

Figure 2-1. Schematic Diagram of MSS Optics

video and calibration data is shown in Figure 2-2. The lower segment of this figure contains a representation of the relative position of the shutter wheel during video data and calibration data acquisition activities.

## **2.2 DETECTORS AND ELECTRONICS**

Bands 1 through 3 use photomultiplier tubes (PMT's) as detectors; band 4 uses silicon photodiodes. The analog video outputs of each detector are sampled by the multiplexer during the west-to-east portion of the mirror scan. The video outputs from each detector are sampled, commutated, and multiplexed into a pulse amplitude modulated (PAM) data stream. The commutated samples of video are either transmitted directly to the analog-to-digital (A/D) converter for encoding or, for bands 1 through 3, directed to a logarithmic signal compression/amplifier and then to the encoder. This selection is made by ground command. The signal compression mode is normally used for bands 1 through 3; no signal compression is performed on band 4.

Compression is applied for the phototube signal to make the quantization noise match the detector noise. Band-4 noise nearly matches the quantization noise in the linear mode of operation.

A high-gain mode is also selectable by ground command. In this mode, a gain of 3 is applied to bands 1 and 2 (only) before A/D conversion. This allows use of the large dynamic range of these detectors. Light reflected from the surface of the Earth is the input radiance to the scan assembly. The video signal for each detector is a voltage that corresponds to this input radiance. In order to get back the values of input radiances from the voltage, a mathematical transformation is required. This transformation relates real-time calibration data to minimum and maximum radiances used in ground processing and will be discussed in a subsequent section.

## **2.3 SCANNER OPTICS OPERATION**

Using the optical configuration previously discussed, the operation of this system must ensure contiguous coverage of the ground track. Since Landsat 4 will orbit at 705 km rather than at

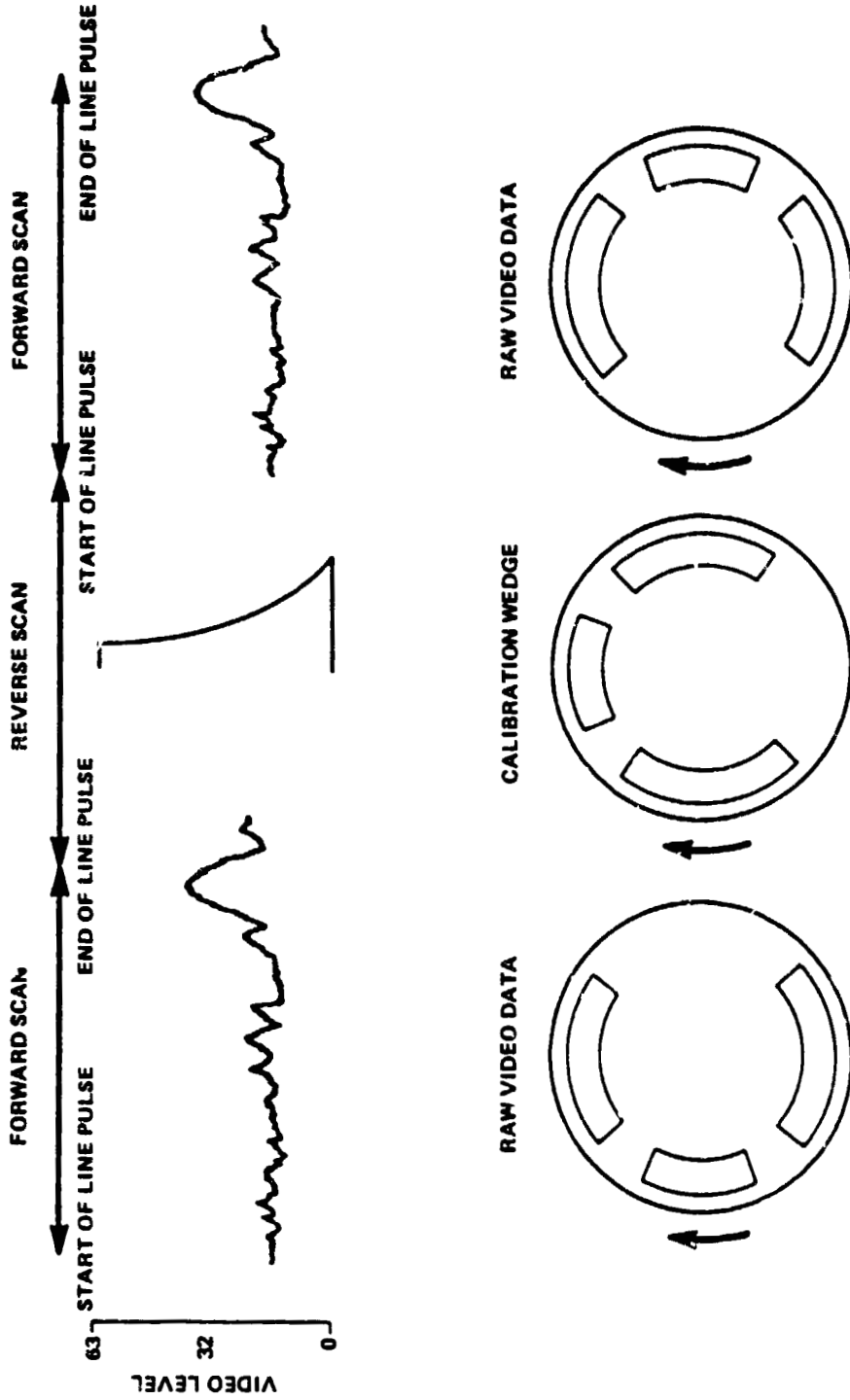

NOTE: CALIBRATION DATA ARE ACQUIRED IN ALTERNATE MIRROR SWEEPS

Figure 2-2. MSS Data Acquisition

920 km used for previous Landsats, some special design changes were required to ensure that the coverage would meet requirements. This required alteration of the instantaneous field of view (IFOV), increase of the cross-track scan angle, and adjustment of the along-track satellite velocity to achieve coverage. The IFOV of each detector is 117.2 microradians. This subtends an Earth square area of 82.7 meters on one side at the planned mean equatorial orbital altitude of 705 km. Field stops are formed for each line imaged during a scan, and for each spectral band, by the square input end of an optical fiber. Six of these fibers in each of four bands are arranged in a 4 by 6 matrix in the exit focal plane of the telescope.

As the flat mirror oscillates, it scans cross-track swaths of 185 kilometers. The lower satellite altitude required that the maximum amplitude of the mirror oscillation be increased to  $\pm 3.75^\circ$  from its nominal position to accommodate this requirement. Previous Landsats used an  $11.56^\circ$  cross-track field of view (FOV); Landsat 4 will use a  $14.9^\circ$  angle to achieve this ground coverage. The relative position of the shutter wheel during data acquisition is illustrated in Figure 2-2. Note that calibration data are acquired in alternate mirror sweeps.

Landsat 4 has been designed for a ground-track velocity of 6.82 km/sec. Oscillating the mirror at a frequency of 13.62 Hz creates a 73.42-msec active scan and retrace period. The optical axis sub-point (subsattellite point) moves 501 meters along the Earth's surface during this period. The width of the FOV of six detectors is also 501 meters. Thus, complete nonredundant coverage of the ground is obtained. The line swept by the first detector in one mirror sweep lies adjacent to the line scanned by the sixth detector of the previous mirror sweep.

## 2.4 MISSION ACQUISITIONS

A schematic of Landsat data acquisitions is presented in Figure 2-3. Each Landsat satellite has been placed in a circular Sun-synchronous orbit. This means that the orbit precesses in inertial space at the same rate at which the Earth moves around the Sun. Past orbital dynamics for Landsat have resulted in the daily coverage of adjacent paths on adjacent orbits with the repeat coverage of any fixed orbital area fixed at 14-day intervals.

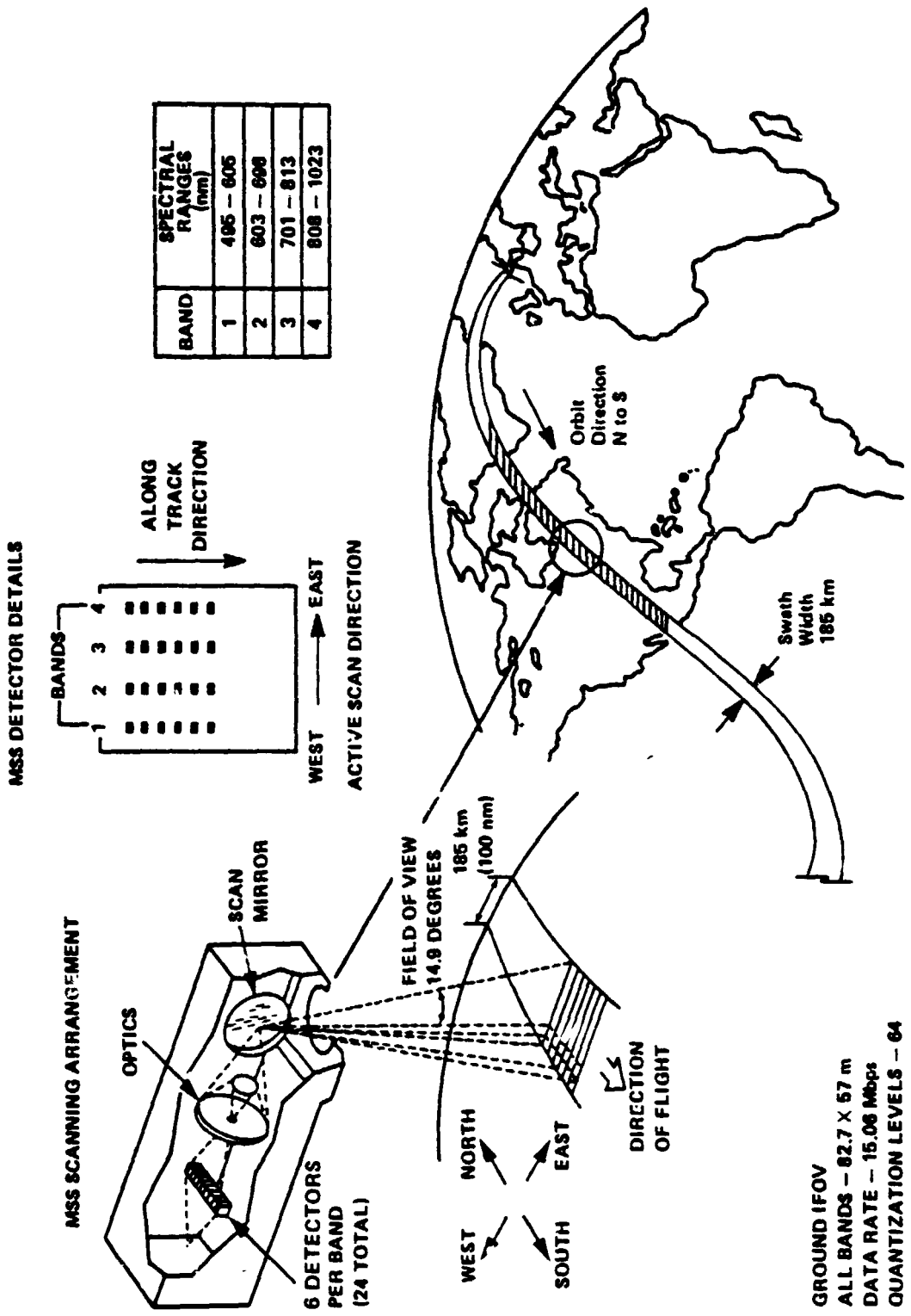

Figure 2-3. Perspective of MSS Data Acquisition

Landsat 4 will differ slightly from this scheme because of its reduced altitude and angle of insertion. The result will be that adjacent orbits will not be covered on the same day as was done for Landsats 1, 2, and 3. For example, for previous Landsats, if orbits 1, 2, and 3 would be covered on day 1, then orbits 15, 16, and 17 would be returned on day 2, since on any one day the satellite made 14 revolutions of the Earth. This allowed duplicate coverage on sequential days for images with sufficiently large scene center latitudes.

The Landsat 4 coverage pattern represents a departure from this scheme because of the orbital characteristics designed for the system. These characteristics (Figure 2-4) illustrate that there will be 14-9/16 orbits per day and adjacent paths will be covered either 7 or 9 days after coverage of the primary path. This difference should be kept in mind by all users.

## **2.5 COMPARISON OF LANDSAT 4 WITH PREVIOUS LANDSATS**

The optical system for Landsat 4 was altered slightly, by design, to accommodate the desired cross-track coverage for the MSS. Other changes were also introduced that have been itemized by the document generated by the Hughes Aircraft Company (1982A). Table 2-1 contains a summary of some of these differences. Differences pertaining to vibration, mass properties, acceleration tolerance, power distribution, the new command system interface, and the telemetry interface are described in detail in this Hughes report and will not be referenced further in this document because of lack of applicability to calibration.

## **2.6 COMPARISON OF UNIT TEST DATA WITH GE THERMAL VACUUM DATA**

Direct comparisons of the Hughes and General Electric (GE) tests are not possible because of the difference in sequence between tests, the difference between reasons for tests, and the difference in configuration (i.e., unit tests versus total integrated system tests). One direct comparison is possible in the context of ensuring that no significant deviations occur. This comparison uses the sensor gain as measured through all orbits for each channel by both Hughes and GE. The plots are arranged so



ALTITUDE: 706.3 km  
 INCLINATION: 98.2  $\phi$ - $\theta$   
 REPEAT PERIOD: 16 days  
 ORBITS/REPEAT PERIOD: 233  
 ORBITS/DAY: 14 9/16  
 TRACE SPACING: 172 km

The distance along the abscissa of the diagram below is essentially the distance between successive orbits on a given day. The intent of this diagram is to show how this distance is covered over the repeat period. The cross hatched boxes show swath location in space and time for Landsat-D

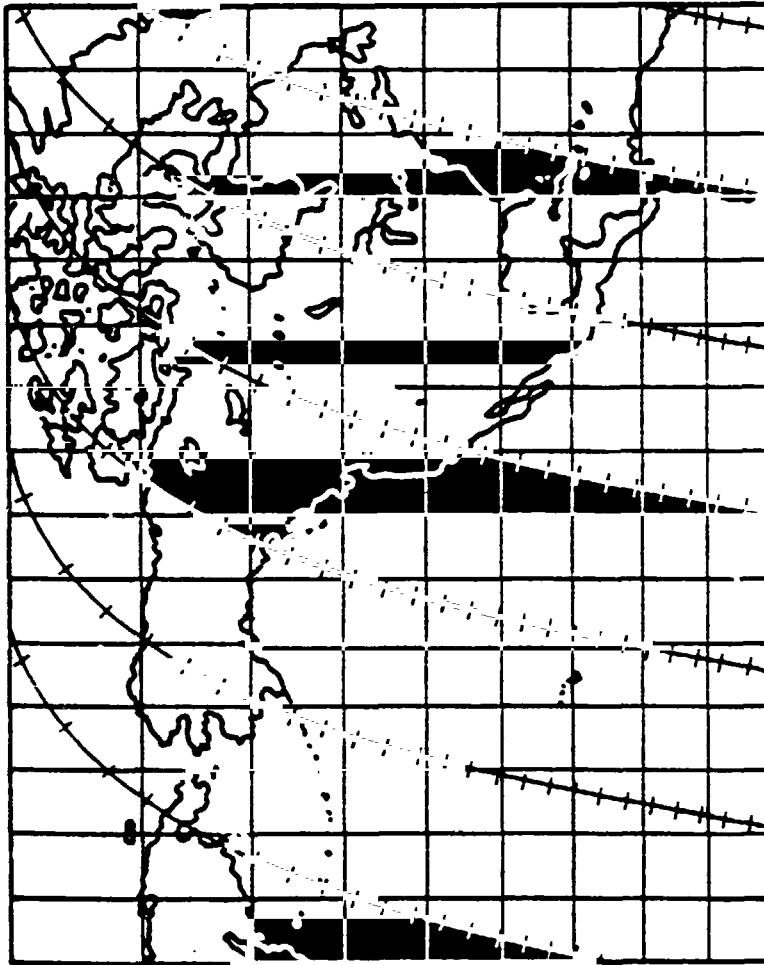
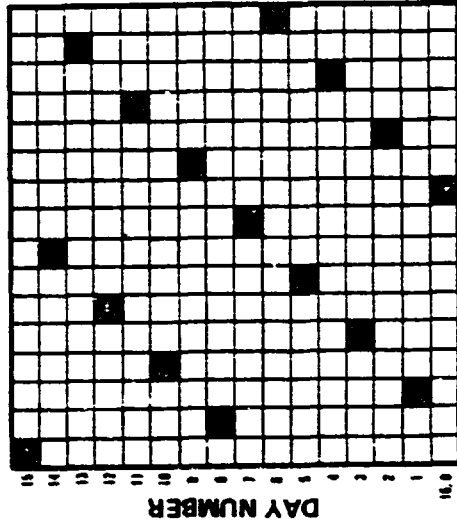

DAY 0, 16
DAY 7
DAY 14
DAY 5
DAY 12
DAY 3
DAY 10
DAY 1
DAY 8
DAY 15
DAY 6
DAY 13
DAY 4
DAY 11
DAY 2
DAY 9
DAY 0, 16

SWATHING PATTERNS

Figure 2-4. Landsat-4 Orbit Characteristics

ORIGINAL PAGE IS OF POOR QUALITY

ORIGINAL PAGE IS  
OF POOR QUALITY

Table 2-1  
MSS Differences for Landsat 3 and Landsat 4

Parameter	Landsat 3	Landsat 4	Comment
IFOV	0.086 milliradians 79 meters	0.1172 milliradians 82 meters	Altitude-Dependent
Scan Angle	11.60 ±0.05 degrees	14.90 ±0.06 degrees	No change
Scan Nonlinearity	+2, -4.3 percent deviation mean scan rate	+2.4, -5.0 percent deviation from mean scan rate	No change in scan mirror mount's spring constant, yet a larger scan angle was required. This increased the scan nonlinearity.
MTF	Larger than 0.29 for 0.075 mradian bars	Larger than 0.36 for 0.102 mradian bars	Scan angle dependent correction made.
Backup Start of Scan Pulse	No requirement	Inserts a pseudo-scan monitor pulse if start of scan is not detected.	New requirement due to problems noted for Landsat 3.

that the Hughes test data reside on the upper portion of the page and the GE data on the lower portion of the page. These results are presented in detail in Appendix A.

## SECTION 3

### MSS SPECTRAL CHARACTERIZATION

#### 3.1 OBJECTIVE

This section summarizes the MSS spectral characterization work performed by Markham and Barker (1981). Their paper contains relative spectral response data for the Landsat-4 generation of Multi-spectral Scanners (MSS's). Reference is made to the protoflight (PF) and flight (F) models throughout their tables of data. The PF model is currently in orbit as the Landsat-4 MSS sensor system. The F model is to be used in the future. The reader should therefore associate PF data with current capabilities and F data with future applications. In this paper, a comparison was made between simulated radiometric response for Landsat 4 and equivalent data for Landsats 1, 2, and 3.

Channel-by-channel (six channels per band) outputs for soil and soybean targets were simulated and compared within each band and between scanners. The primary objective of their study was to make available to the Landsat user community data on the spectral characteristics of these two sensors, including a characterization of the variability within and differences between the two new sensor systems. These data can be used by individual investigators to assess MSS data utility for each unique application. A second objective was to provide, through simulation, an estimate of the potential contribution of spectral differences between channels to within-band striping, often referred to as "spectral striping." This should not be confused with radiometric striping, which is due to gain or offset differences between channels within a band. Since spectral striping cannot be removed by uniform radiometric calibration, it represents a fundamental limit to the ability to remove banding.

Subsection 3.2 describes procedures used in this spectral analysis; subsection 3.3 presents some results obtained by Markham and Barker; subsection 3.4 compares Landsat-4 data with those from Landsats 1, 2, and 3; and subsection 3.5 presents some concluding remarks resulting from this comparison.

### **3.2 PROCEDURE**

Relative spectral response (RSR) curves for each channel of the Landsat-4 series MSS's (Hughes, 1980, 1981a, and 1981b), as well as the MSS's on Landsat 1, Landsat 2 (Norwood *et al.*, 1972), and Landsat 3 (Felkel *et al.*, 1977), were digitized at 10-nm intervals for bands 1, 2, and 3 and at 20-nm intervals for band 4. Data acquired in 1981 for the current MSS were used for this characterization.

From the digitized curves, the following attributes were computed:

- Lower bandedge (50 percent relative response point)
- Upper bandedge (50 percent relative response point)
- Lower edge slope interval (width between lower 5 and 50 percent response points)
- Upper edge slope interval (width between upper 5 and 50 percent response points)
- Spectral flatness (maximum positive and negative deviation from mean response in central 70 percent of nominal bandpass)

These five characteristics were considered appropriate to characterize the overall relative spectral response. In addition, bandwidth (bandedge to bandedge) was calculated. For each band, the band mean (the average value of the characteristic for the six channels in the band) and the band standard deviation were also calculated.

### **3.3 RESULTS**

Data obtained by Markham and Barker are included for the protoflight MSS system, with the authors' permission. Figure 3-1 shows the resultant output for one sensor of band 1. Table 3-1 gives measured channel-by-channel responses for the Landsat-4 system. Tables 3-2 through 3-6 present data from which a comparison with other MSS sensors can be made.

### **3.4 COMPARISON WITH PREVIOUS LANDSATS**

Both protoflight and flight MSS systems were studied. The spectral characterization results presented in Tables 3-2 through 3-6 are summarized as follows:

ORIGINAL PAGE IS  
OF POOR QUALITY

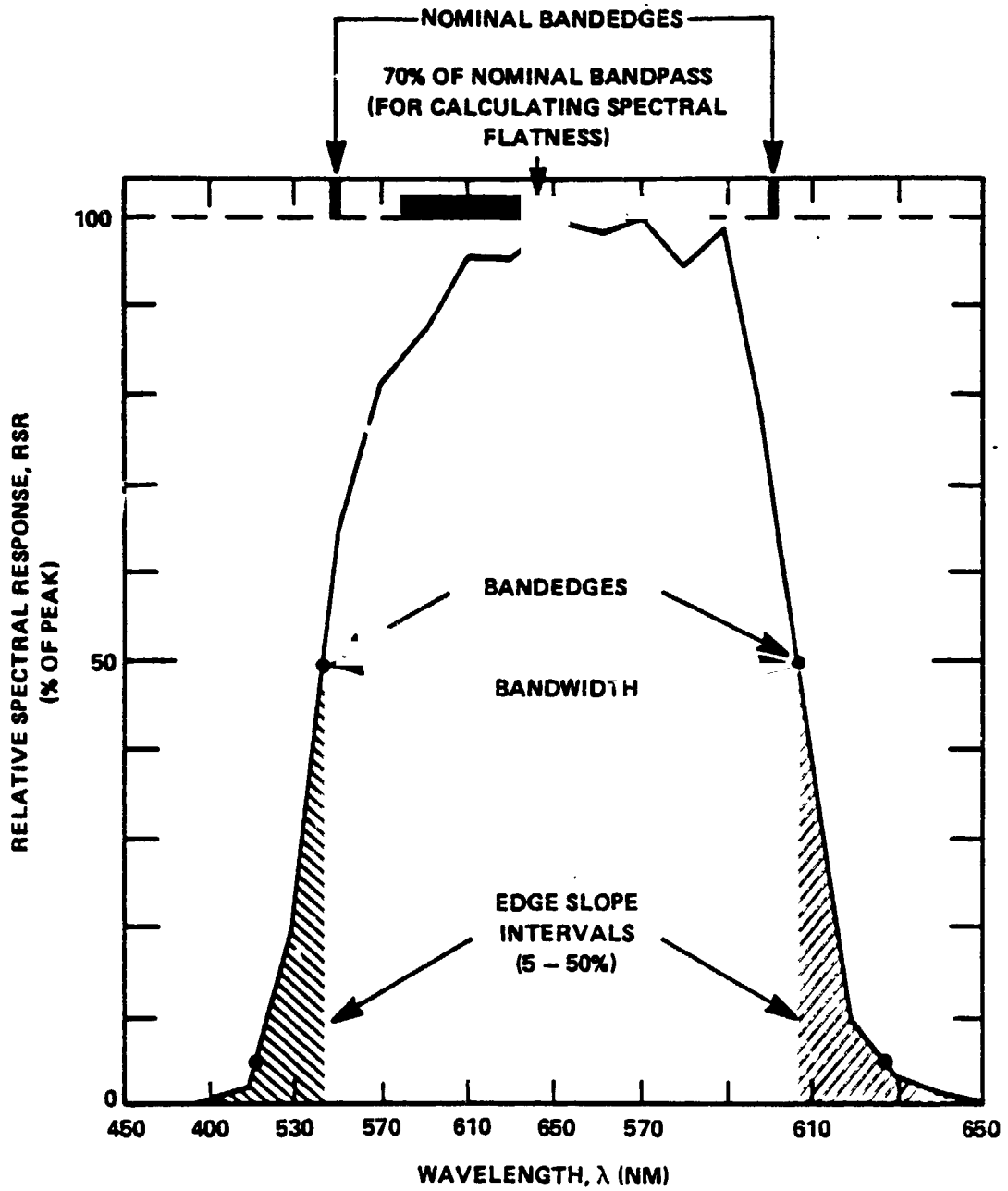

Figure 3-1. Relative Spectral Response for an MSS Sensor

Table 3-1  
MSS Optical Filter Specification

Band	Bandedge (nm) Half Power Points		Band- Width (nm)	Slope Interval (nm) From 5 to 50%		Spectral Flatness (%) Over Central 70%	
	Lower	Upper		Lower	Upper	Positive	Negative
1	500 +10	600 +10	-	<20	<40	<5.0	<5.0
2	600 +10	700 +10	-	<20	<45	<7.5	<7.5
3	700 +10	800 +10	-	<20	<50	<5.0	<5.0
4	800 +10	1100 <sup>a</sup> +10	-	<35	-	<5.0	<5.0

<sup>a</sup>Upper bandedge not filter determined - Filter specification necessary for flatness determination

Table 3-2  
Spectral Characterization by Channel for the Landsat-4 MSS

Scanner Channel	Bandedge (nm)		Width <sup>a</sup> (nm)	Slope Interval (nm)		Spectral Flatness		
	Lower	Upper		Lower	Upper	Positive	Negative	
Band 1	1	496	606	110	15	22	4.4	7.1 <sup>b</sup>
	2	496	605	109	15	22	3.5	5.8 <sup>b</sup>
	3	496	605	109	15	23	5.6 <sup>b</sup>	9.2 <sup>b</sup>
	4	495	604	109	15	24	6.0 <sup>b</sup>	10.8 <sup>b</sup>
	5	495	603	108	14	24	6.0 <sup>b</sup>	13.1 <sup>b</sup>
	6	495	606	110	15	22	4.8	7.8 <sup>b</sup>
Band 2	7	603	708 <sup>c</sup>	105 <sup>c</sup>	12	19	8.2 <sup>b</sup>	17.2 <sup>b</sup>
	8	602	696	94	12	16	6.4	11.6 <sup>b</sup>
	9	603	696	92	12	14	6.6	11.0 <sup>b</sup>
	10	603	696	94	12	18	7.8 <sup>b</sup>	11.1 <sup>b</sup>
	11	604	698	94	13	17	4.5	11.7 <sup>b</sup>
	12	602	695	93	12	15	8.2 <sup>b</sup>	14.5 <sup>b</sup>
Band 3	13	700	813 <sup>b</sup>	113	16	14	13.7 <sup>b</sup>	14.2 <sup>b</sup>
	14	701	812 <sup>b</sup>	110	16	15	11.6 <sup>b</sup>	15.7 <sup>b</sup>
	15	701	814 <sup>b</sup>	113	15	14	12.9 <sup>b</sup>	8.6 <sup>b</sup>
	16	702	814 <sup>b</sup>	111	15	14	7.8 <sup>b</sup>	10.0 <sup>b</sup>
	17	701	813 <sup>b</sup>	112	15	15	13.0 <sup>b</sup>	13.0 <sup>b</sup>
	18	701	812 <sup>b</sup>	111	15	16	18.5 <sup>b</sup>	15.3 <sup>b</sup>
Band 4	19	808	1025	217	23	110	25.5 <sup>b</sup>	48.5 <sup>b</sup>
	20	808	1006	199	23	120	36.7 <sup>b</sup>	62.2 <sup>b</sup>
	21	808	1049	241	24	94	19.5 <sup>b</sup>	44.8 <sup>b</sup>
	22	807	1012	205	23	117	34.9 <sup>b</sup>	59.5 <sup>b</sup>
	23	807	1025	218	23	108	31.1 <sup>b</sup>	50.2 <sup>b</sup>
	24	807	1018	211	23	112	29.3 <sup>b</sup>	56.7 <sup>b</sup>

<sup>a</sup>No filter specification  
<sup>b</sup>Fails to meet filter specification  
<sup>c</sup>Rejectable as outlier:  $\alpha = 0.01$



Table 3-3  
Characterization of Landsat-4 MSS (Band 1) and Comparison  
with Landsats 1, 2, and 3

	Scanner	Bandedge (nm)		Width <sup>a</sup> (nm)	Slope Interval (nm)		Spectral Flatness	
		Lower	Upper		Lower	Upper	Positive	Negative
Means	PF	495	605	109	15	23	5.1 <sup>b</sup>	8.9 <sup>b</sup>
	F	497	607	109	15	21	5.0	11.2 <sup>b</sup>
	1 <sup>c</sup>	501	599	98	15	27	7.1 <sup>b</sup>	16.1 <sup>b</sup>
	1 <sup>d</sup>	499	597	98	15	27	6.1 <sup>b</sup>	14.6 <sup>b</sup>
	2	497	598	101	15	22	5.4 <sup>b</sup>	14.1 <sup>b</sup>
	3	497	593	96	16	22	5.4 <sup>b</sup>	19.2 <sup>b</sup>
Standard Deviations	PF	0.5	1.2	0.8	0.3	1.0	1.0	2.7
	F	0.8	0.8	0.5	0.6	0.7	0.6	3.4
	1 <sup>c</sup>	6.5	4.1	3.5	1.6	5.6	2.4	6.4
	1 <sup>d</sup>	5.3	3.0	3.5	1.8	5.4	0.4	5.8
	2	1.4	1.4	1.8	1.2	0.6	2.4	3.5
	3	3.7	2.5	3.8	3.2	3.4	1.5	7.8

<sup>a</sup>No filter specification  
<sup>b</sup>fails to meet filter specification  
<sup>c</sup>With outlier channel included  
<sup>d</sup>With outlier channel excluded

Boxes indicate characteristics where differences between PF<sup>a</sup> or F and all previous scanners (1, 2, 3) were greater than differences between two sets of PF measurements.

Table 3-4  
Characterization of Landsat-4 MSS (Band 2) and Comparison  
with Landsats 1, 2, and 3

Scanner	Bandedge (nm)		Width* (nm)	Slope Interval (nm)		Spectral Flatness		
	Lower	Upper		Lower	Upper	Positive	Negative	
Means	PF <sup>c</sup>	603	698	95	12	16	7.0	12.9 <sup>b</sup>
	PF <sup>d</sup>	603	696	93	12	16	6.7	12.0 <sup>b</sup>
	F	603	697	94	12	15	7.6 <sup>b</sup>	11.1 <sup>b</sup>
	1	603	701	97	15	26	9.0 <sup>b</sup>	13.3 <sup>b</sup>
	2 <sup>c</sup>	607	710	103	14	30	7.9 <sup>b</sup>	18.0 <sup>b</sup>
	2 <sup>d</sup>	607	710	103	14	29	7.8 <sup>b</sup>	16.8 <sup>b</sup>
3	606	705	100	14	31	7.2	17.2 <sup>b</sup>	
Standard Deviations	PF <sup>c</sup>	0.7	4.7	4.8	0.5	1.9	1.4	2.5
	PF <sup>d</sup>	0.8	0.8	0.6	0.5	1.4	1.5	1.4
	F	0.4	0.6	0.5	0.4	0.9	1.2	3.0
	1	3.5	2.2	2.8	1.7	3.4	3.4	2.8
	2 <sup>c</sup>	0.6	0.8	1.0	1.2	2.7	1.1	4.5
	2 <sup>d</sup>	0.6	0.9	1.1	1.2	2.6	1.2	3.8
3	0.9	1.2	0.8	0.8	2.0	2.0	4.8	

<sup>a</sup>No filter specification  
<sup>b</sup>Fails to meet filter specification  
<sup>c</sup>With outlier channel included  
<sup>d</sup>With outlier channel excluded

Boxes indicate characteristics where differences between PF of F and all previous scanners (1, 2, 3) were greater than differences between two sets of PF measurements.

Table 3-5  
Characterization of Landsat-4 MSS (Band 3) and Comparison  
with Landsats 1, 2, and 3

	Scanner	Bandedge (nm)		Width <sup>a</sup> (nm)	Slope Interval (nm)		Spectral Flatness	
		Lower	Upper		Lower	Upper	Positive	Negative
Means	PF	701	813 <sup>b</sup>	112	15	15	13.2 <sup>b</sup>	12.8 <sup>b</sup>
	F	704	814 <sup>b</sup>	110	16	16	12.6 <sup>b</sup>	9.6 <sup>b</sup>
	1	694	800	105	19	19	7.2 <sup>b</sup>	7.4 <sup>b</sup>
	2	697	802	106	16	16	8.4 <sup>b</sup>	7.9 <sup>b</sup>
	3	693	793	100	19	19	9.9 <sup>b</sup>	22.2 <sup>b</sup>
	PF	0.7	0.9	1.1	0.3	0.3	2.9 <sup>c</sup>	2.9 <sup>c</sup>
Standard Deviations	F	0.3	0.2	0.3	1.0	1.0	1.1 <sup>c</sup>	0.8 <sup>c</sup>
	1	0.9	1.0	0.9	2.0	2.0	3.2	2.9
	2	1.1	2.3	2.1	0.6	0.6	3.0	1.9
	3	1.8	1.6	0.8	1.4	1.4	2.7	3.4
	PF	0.7	0.9	1.1	0.3	0.3	2.9 <sup>c</sup>	2.9 <sup>c</sup>
	F	0.3	0.2	0.3	1.0	1.0	1.1 <sup>c</sup>	0.8 <sup>c</sup>

<sup>a</sup>No filter specification

<sup>b</sup>Fails to meet filter specification

<sup>c</sup>PF, F difference exceeds difference between two sets of PF measurements

Boxes indicate characteristics where differences between PF<sub>i</sub> or F<sub>i</sub> and all previous scanners (1, 2, 3) were greater than differences between two sets of PF measurements.

Table 3-6  
Characterization of Landsat-4 MSS (Band 4) and Comparison  
with Landsats 1, 2, and 3

	Scanner	Bandedge (nm)		Width <sup>a</sup> (nm)	Slope Interval (nm)		Spectral Flatness	
		Lower	Upper		Lower	Upper	Positive	Negative
Means	PF	808	1023	215	23	110	29.8 <sup>b</sup>	53.7 <sup>b</sup>
	F	809	1036	227	23	101	23.0 <sup>b</sup>	50.8 <sup>b</sup>
	1	810	989	179	22	120	46.0 <sup>b</sup>	44.5 <sup>b</sup>
	2	807	990	183	23	118	45.4 <sup>b</sup>	45.9 <sup>b</sup>
	3	812 <sup>b</sup>	979	167	24	108	56.4 <sup>b</sup>	80.7 <sup>b</sup>
	PF	0.5	14.9	14.6	0.2	9.2	6.8	6.8 <sup>c</sup>
Standard Deviations	F	0.1	12.5	12.5	0.4	9.9	6.0	4.1 <sup>c</sup>
	1	1.2	3.5	3.7	2.1	7.2	2.3	3.1
	2	2.0	4.0	5.3	0.8	2.7	4.7	1.1
	3	0.9	7.9	7.6	1.0	3.0	11.7	2.4

<sup>a</sup>No filter specification

<sup>b</sup> fails to meet filter specification

<sup>c</sup>PF, F difference exceeds difference between two sets of PF measurements.

Boxes indicate characteristics where differences between PF, or F and all previous scanners (1, 2, 3) were greater than differences between two sets of PF measurements.

**Band 1:** No outliers, relative spectral responses meet all filter specifications except flatness (Table 3-2).

**Band 2:** PF channel 7 upper bandedge is 12 nm higher than the average of the other PF channels and is rejectable as an outlier; responses meet all filter specifications except flatness (Table 3-3).

**Band 3:** No outliers, all channels are slightly wide (2 to 4 nm) to the long wavelength side, otherwise responses meet filter specifications.

**Band 4:** No outliers, but upper bandedge varies by as much as 42 nm, resulting in width variations of up to 20 percent; system response upper half-power points below filter specifications due to silicon photodiode detector response; and response flatness considerably below filter specifications (Table 3-5).

### **3.5 CONCLUSIONS**

The two Landsat-4 scanners are nearly identical in mean spectral response; however, some difference from previous MSS systems was found. Principal differences between the spectral responses of the Landsat-4 scanners and previous systems are itemized as follows:

- A mean upper bandedge in the green band of 606 nm was observed for Landsat 4 as compared with previous means of 593 to 598 nm.
- An average upper bandedge of 697 nm in the red band was observed for Landsat 4 as compared with previous averages of 701 to 710 nm.
- An average bandpass for the first near-infrared band of 702 to 814 nm was found for Landsat 4 compared with a range of 693 to 793 nm to 697 to 802 nm for previous scanners.

These differences resulted in the simulated Landsat-4 scanner outputs being 3 to 10 percent lower in the red band and 3 to 11 percent higher in the first near-infrared band than previous scanners when viewing a soybean target. Otherwise, outputs from soil and soybean targets were little

affected. The Landsat-4 scanners generally appear to be more uniform in both channel-to-channel and band-to-band responses than previous scanners.

SECTION 4

PRELAUNCH MSS SENSOR RADIOMETRIC CHARACTERIZATION

4.1 INTRODUCTION

This section introduces the reader to the calibration procedures performed on the Landsat-4 MSS instrument during prelaunch activities.

Radiometric calibration converts output voltage from the MSS photodetectors into digital values that represent input radiance. This is accomplished by using the voltage-radiance characteristics of each detector. Detector characteristics are monitored and updated using an internal calibration system. The MSS internal calibration system consists of a wedge density filter between a calibration lamp and the detectors. The internal calibration lamp, which is used as a reference, is calibrated prelaunch using a GSFC 76-cm integrating sphere. This integrating sphere is the primary standard for the radiometric calibration of the MSS. The objective of the prelaunch MSS radiometric calibration using this sphere is to establish the reference light levels of the internal calibrator lamp for all channels (detectors) in the four bands.

There are several radiance levels (illumination intensities) associated with the integrating sphere, which corresponds to different numbers of lamps, that are turned on within it. In a typical calibration experiment in the laboratory, the MSS is exposed to different intensities (radiances) from the sphere. For each output radiance level,  $R_j$ , of the integrating sphere, the MSS registers a digital count,  $V_j$ , that is obtained as an average over several mirror sweeps. During retrace motion of alternate scans (Figure 4-1), the shutter wheel within the scan mirror assembly is used to transmit light from the internal lamp through a graded density filter. This produces a wedge-shaped signal from the internal lamp. Because of hysteresis effects, detector readings for any given word location on the wedge will be different, corresponding to different radiance levels from the integrating sphere. Figure 4-2 conceptually shows how detector readings,  $Q_{ij}$ , corresponding to internal lamp wedge word location,  $i$ ,

ORIGINAL PAGE IS  
OF POOR QUALITY

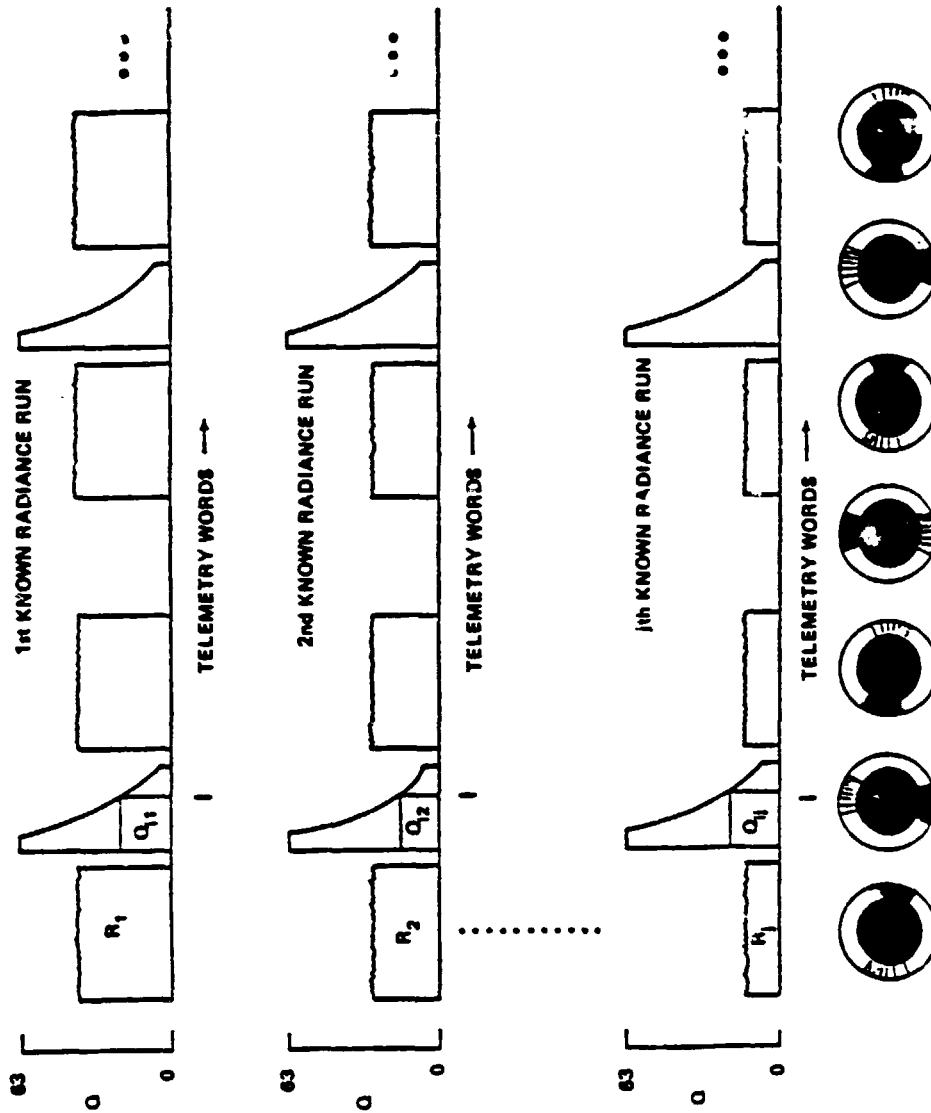
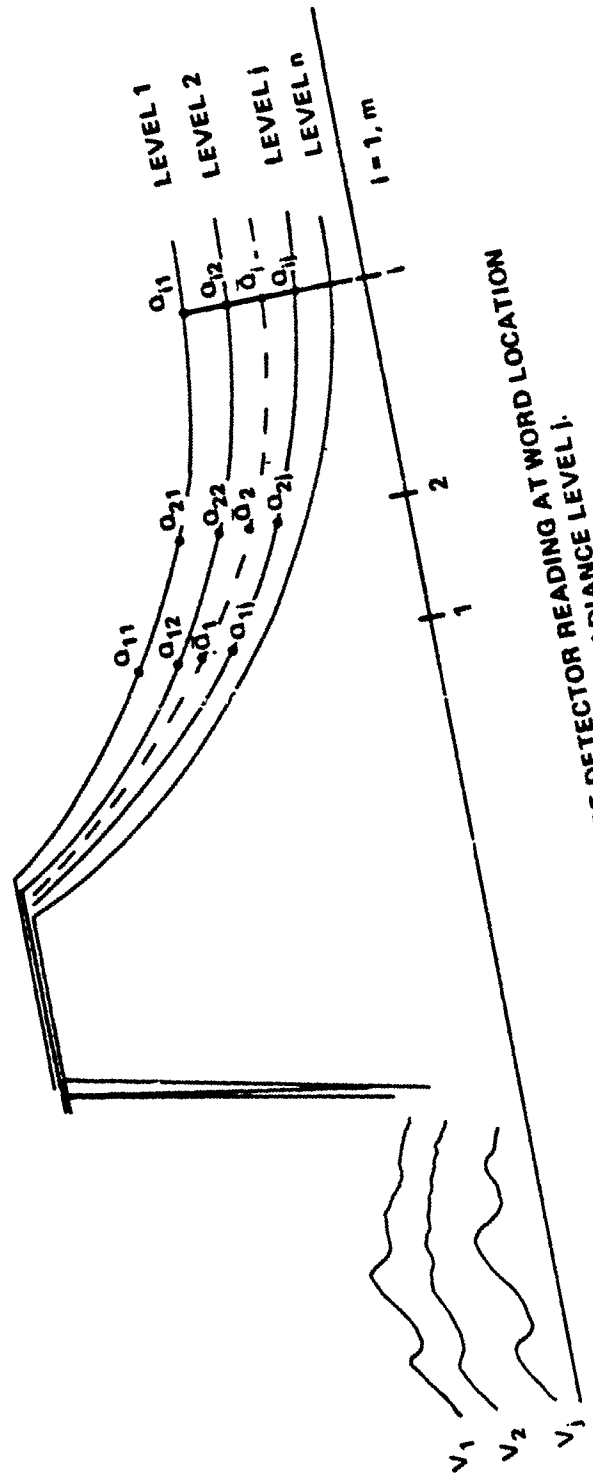

Figure 4-1. Systematic MSS Video and Wedge Level Timing Sequence



ORIGINAL PAGE IS  
OF POOR QUALITY



NOTE:  $\bar{O}_1$  REPRESENTS AVERAGE DETECTOR READING AT WORD LOCATION  
 $\bar{O}_1$  OVER ALL INTEGRATING SPHERE RADIANCE LEVEL I.

Figure 4-2. Hysteresis Effects on Detector Readings

for different integrating sphere radiance levels,  $j$ , may change due to hysteresis. Similarly, the digital readings  $V_j$  for the sphere radiance levels  $R_j$  are also affected by hysteresis.

During calibration analysis in the laboratory, corrections to hysteresis effects are made to  $V_j$ 's to obtain adjusted, digital values,  $VA_j$ , for each radiance level  $R_j$ . A linear transformation between  $VA_j$  and  $R_j$  is then assumed. Using the coefficients of this transformation (which are evaluated), the radiance,  $R_1$ , at the internal lamp wedge word locations is calculated. Radiance values corresponding to six preselected word locations on this wedge are then used to compute the gain and offset of the detector. Details of this procedure are presented as six distinct steps in the following section.

#### 4.2 CALIBRATION PROCEDURE

The entire calibration process involves the following steps for each detector of each band.

##### STEP 1: Determination of Equivalent Radiance of the Integrating Sphere

The integrating sphere was calibrated at CSFC using a grating spectroradiometer, by comparing the output from the sphere with that of a standard of spectral irradiance (Reference HS 248-5660-3-1). The integrating sphere uses tungsten lamps that are not spectrally flat. The equivalent spectrally flat radiance of the integrating sphere must therefore be determined independently for each detector within a band. The equivalent spectrally flat radiance of the integrating sphere for any detector is determined from

$$R_{jk} = BW_k \frac{\int RW_j RSR_k d_\lambda}{\int RSR_k d_\lambda} \quad (4-1)$$

where

$R_{jk}$  = equivalent spectrally flat emittance for integrating sphere level  $j$  ( $\text{mW}/\text{cm}^2 \text{ sr}$ ) for detector  $k$

$BW_k$  = bandwidth of detector  $k$  at 50 percent of peak value

$RW_j$  = spectral radiant emittance of the integrating sphere for level  $j$  ( $\text{mW}/\text{cm}^2 \mu \text{sr}$ ). A plot of  $RW_j$  versus wavelength is shown in Figure 4-3.

$RSR_k$  = relative spectral response of detector  $k$  (dimensionless)

### STEP 2: Selection of Calibration Wedge Words for Each Band

During the retrace interval of alternate scans, a shutter wheel closes off the optical system's view of the scene. At this time, light from an internal lamp is projected into the sensor through a graded density filter that resides on the shutter wheel. This produces a unique wedge-shaped video data stream at each detector. The detector responses at six word locations on this calibration wedge are selected to represent sample video data from the internal lamp. These word counts are referenced to the first sample on the leading edge greater than level 32 (see Figure 4-4). The particular word locations are selected on the basis of the following factors:

- Temperature Effects—Detector gains and offset are a function of temperature.
- Detector Aging—Previous detectors have experienced long-term drift effects, particularly for Landsat 1, channel 13.
- Hysteresis—Detector gain changes as a function of incident radiance.
- Vacuum—Detector gain and offset shift somewhat when the MSS is introduced to the vacuum conditions of space.

### STEP 3: Adjustment of Integrating Sphere Video Levels

As the system is run through a sequence of radiance levels  $R_j$  from the sphere, average video digital counts  $V_j$  corresponding to a radiance level  $R_j$  (as seen in the scene) must be adjusted to

ORIGINAL PAGE IS  
OF POOR QUALITY

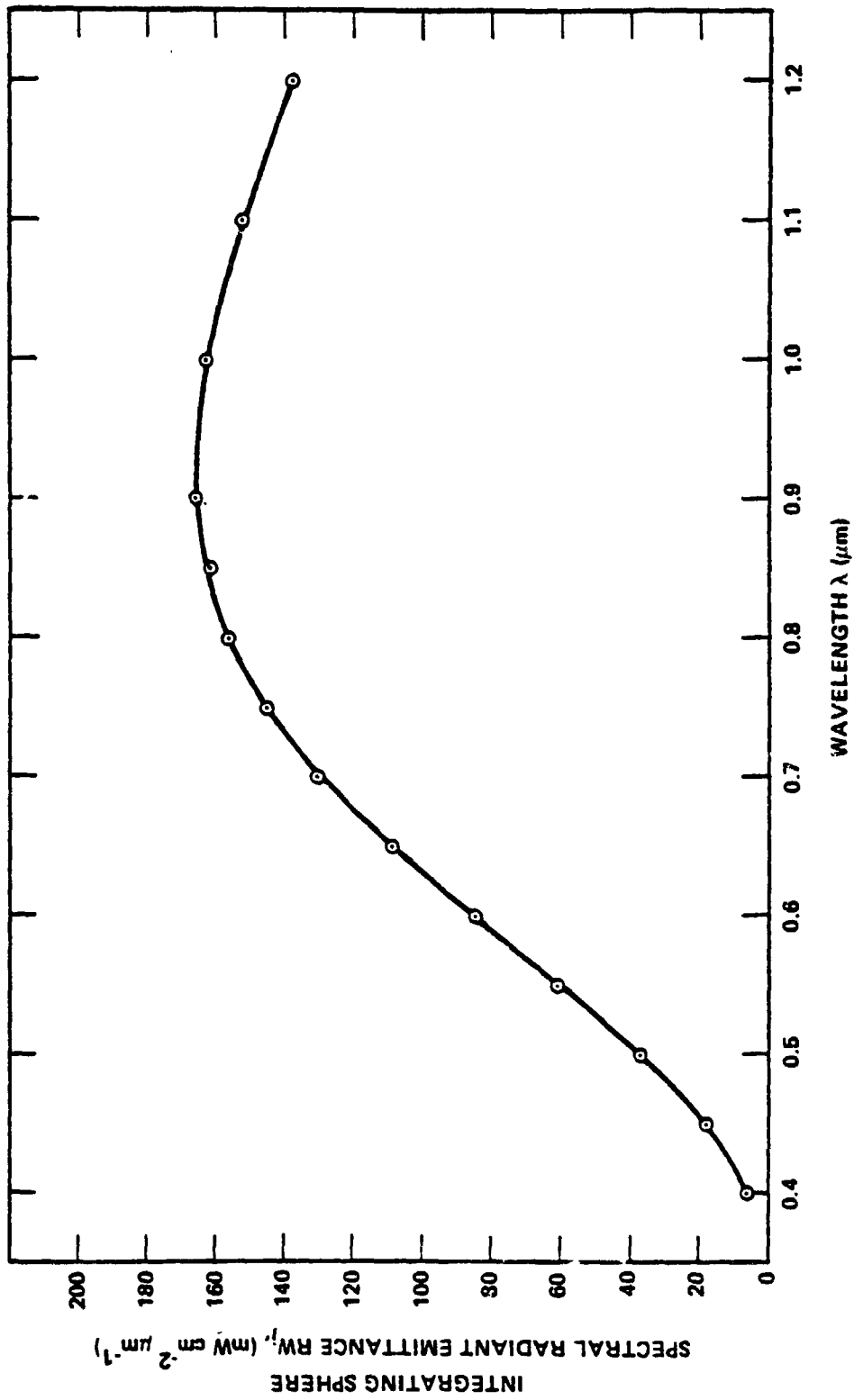

Figure 4-3. Spectral Radiant Emittance Plot for 76-cm Integrating Sphere

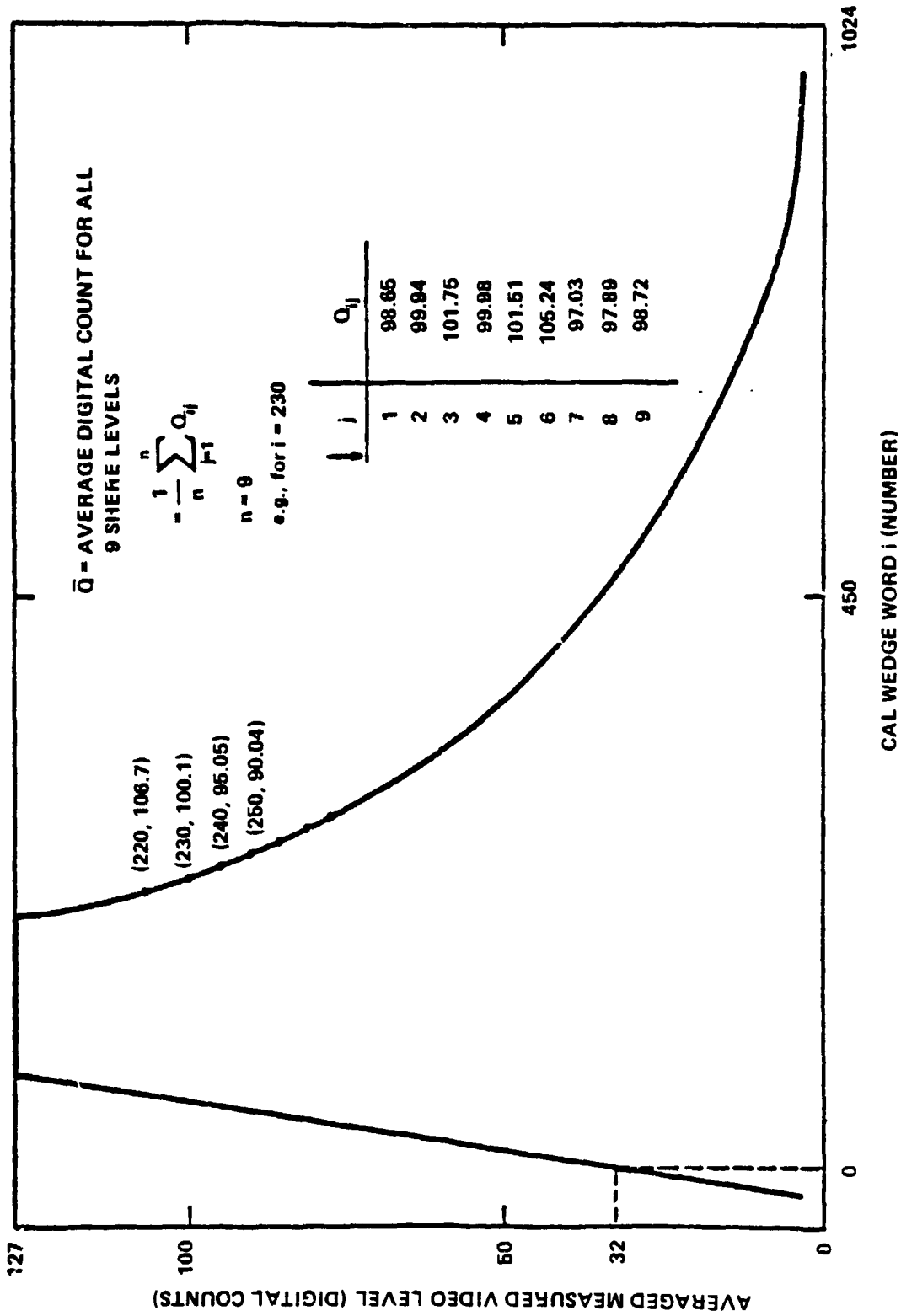

Figure 4-4. Illustrative MSS Lamp Calibration Wedge

compensate for the effects of detector hysteresis. If  $Q_{ij}$  is the calibration wedge digital count for the  $i$ th calibration word location, corresponding to the  $j$ th radiance level from the sphere, then

$$\bar{Q}_i = \frac{1}{n} \sum_{j=1}^n Q_{ij} \quad (4-2)$$

is the average wedge digital count for wedge word location  $i$ . Assuming a linear relationship between  $\bar{Q}_i$  and  $Q_{ij}$ ,

$$Q_{ij} = a_j + b_j \bar{Q}_i \quad (4-3)$$

It should be noted that GE used 14 word locations ( $i = 1 \dots 14$ ) on the internal lamp wedge and 9 radiance levels ( $j = 1 \dots 9$ ) from the integrating sphere.

Summing overall word locations ( $i$ ) for a given level ( $j$ ) produces

$$\sum_{i=1}^m Q_{ij} = ma_j + b_j \sum_{i=1}^m \bar{Q}_i \quad (4-4)$$

Equation (4-3), when multiplied by  $\bar{Q}_i$  and summed over  $i$ , yields

$$\sum_{i=1}^m \bar{Q}_i Q_{ij} = a_j \sum_{i=1}^m \bar{Q}_i + b_j \sum_{i=1}^m (\bar{Q}_i)^2 \quad (4-5)$$

Equations (4-4) and (4-5) are solved simultaneously for  $a_j$  and  $b_j$ .

This produces

$$a_j = \left[ \sum_{i=1}^m \bar{Q}_i^2 \sum_{i=1}^m Q_{ij} - \sum_{i=1}^m \bar{Q}_i \sum_{i=1}^m \bar{Q}_i Q_{ij} \right] / D_j \quad (4-6)$$

and

$$b_j = \left[ m \sum_{i=1}^m \bar{Q}_i Q_{ij} - \sum_{i=1}^m \bar{Q}_i \sum_{i=1}^m Q_{ij} \right] / D_j \quad (4-7)$$

where

$$D_1 = m \sum_{i=1}^m \bar{Q}_i^2 - \left( \sum_{i=1}^m \bar{Q}_i \right)^2 \quad (4-8)$$

It should be noted that since the coefficients  $a_j$  and  $b_j$  connect individual  $Q_{ij}$ 's with the average  $\bar{Q}_i$ ,  $b_j$  should be near unity and  $a_j$  should be very small. The coefficients  $a_j$  and  $b_j$  can now be used to adjust the integrating sphere video digital values  $V_j$  to correct for hysteresis effects.

$$V_j = a_j + b_j VA_j$$

#### STEP 4: Equivalent Radiance ( $R_i$ ) Values at Wedge Word Locations

Assume that a linear relationship exists between adjusted video digital count  $VA_j$  and the corresponding radiance level  $R_j$  of the sphere. Or,

$$VA_j = p + q R_j \quad (4-9)$$

The values  $p$  and  $q$  are solved by a least-squares fit (as before for  $a_j$  and  $b_j$ ) of the data sequence over  $j$ . Assuming that these detector transfer coefficients apply to the calibration lamp, an equivalent calibration lamp radiance can be calculated for each of 14 wedge-word location  $i$  from

$$R_i = \frac{\bar{Q}_i - p}{q} \quad (4-10)$$

#### STEP 5: Calibration Coefficients $C_i$ and $D_i$

From the 14 radiance values computed in equation (4-10), six radiance values corresponding to previously prescribed word locations are chosen, and a new linear relationship is assumed between these six radiance values and the corresponding average wedge digital counts  $\bar{Q}_i$ .

$$\bar{Q}_i = \alpha + \beta R_i \quad (4-11)$$

where

$$\alpha = \sum_{i=1}^6 \bar{Q}_i C_i \quad \rightarrow \text{the offset}$$

$$\beta = \sum_{i=1}^6 \bar{Q}_i D_i \quad \text{is the gain}$$

where

$$C_i = \left( \sum_{i=1}^6 R_i^2 - R_i \sum_{i=1}^6 R_i \right) / K_i$$

$$D_i = \left( 6R_i - \sum_{i=1}^6 R_i \right) / K_i$$

$$K_i = 6 \sum_{i=1}^6 R_i^2 - \left( \sum_{i=1}^6 R_i \right)^2$$

These are the calibration coefficients.

It should be noted that all the foregoing computations are performed to produce six  $C_i$ 's and  $D_i$ 's for each channel of every band (Figure 4-5).

#### STEP 6: Sensor Transformation Equation

Since the six detectors of a given band have different gains and offsets, the detectors may saturate at different input radiance levels. Similarly, zero digital values may result at different low-input radiance for different detectors. This will cause striping. To eliminate striping, each detector response for the set of six detectors in a band is mapped to a common band calibration curve. To achieve this, first identify the detector that saturates first. Let  $R_{max}$  be the radiance value slightly



ORIGINAL PAGE IS  
OF POOR QUALITY

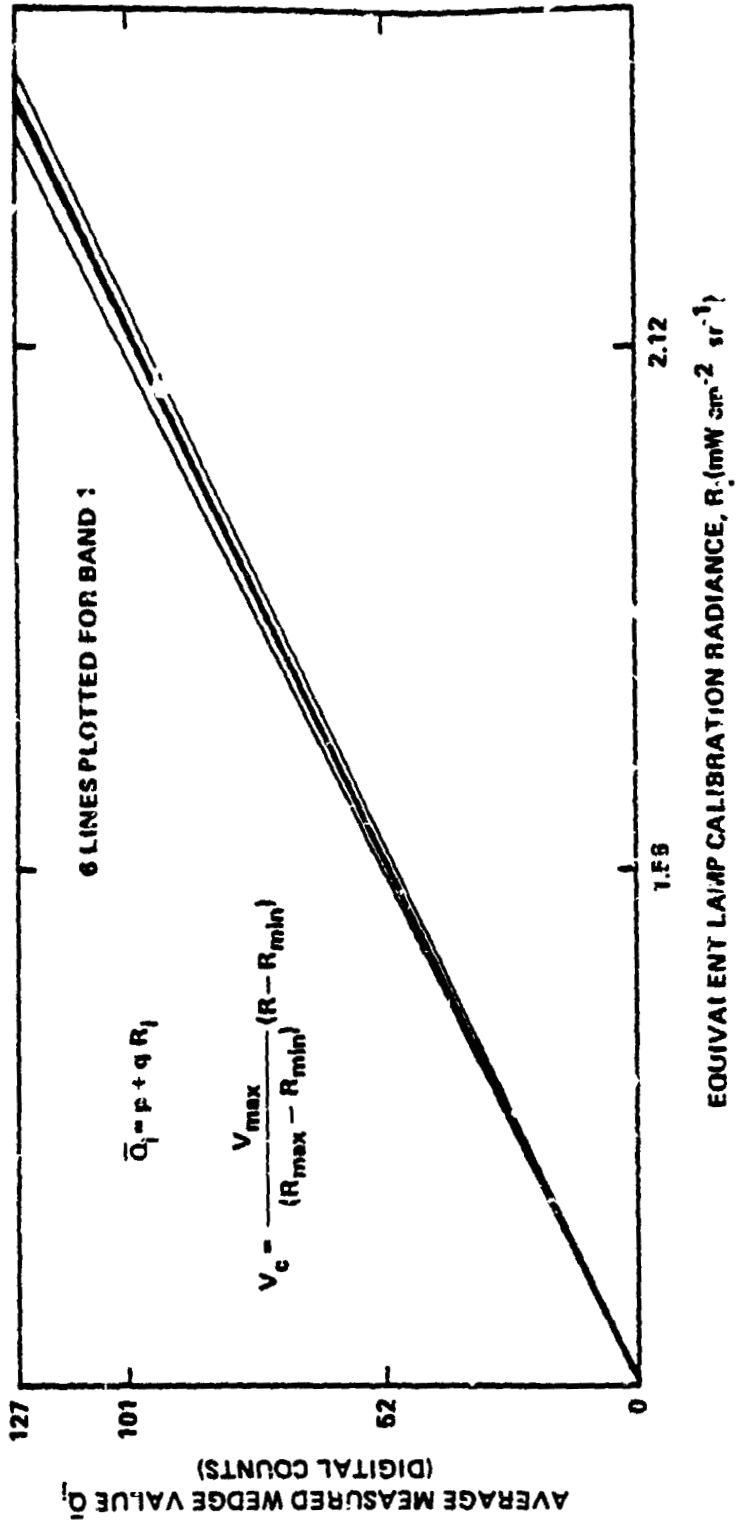

Figure 4-5. Band Normalization of MSS Channel Gains and Offset

lower than the lowest incident radiance that saturates this detector. Let  $R_{min}$  be the radiance slightly higher (chosen from experience to be 10 percent higher) than the highest value of input radiance that produces zero output from one detector. Let  $V_{max}$  (typically 127 for the logarithmically compressed modes for bands 1, 2, and 3) be the maximum digital count from the detectors (after decompression). Let  $R$  be apparent input scene radiance and  $V_o$  be the actual observed video digital count corresponding to  $R$ . Then, the corrected video digital count  $V_c$  corresponding to input  $R$  is given by

$$V_c = \frac{V_{max}}{R_{max} - R_{min}} (R - R_{min}) \quad (4-12)$$

From equation (4-11),  $V_o$  and  $R$  are related by the equation

$$V_o = \alpha + \beta R$$

or

$$R = \frac{1}{\beta} (V_o - \alpha) \quad (4-13)$$

Substituting in equation (4-12),

$$V_c = \frac{V_{max}}{R_{max} - R_{min}} \left( \frac{V_o - \alpha}{\beta} - R_{min} \right) \quad (4-14)$$

Equation (4-14) maps all six detectors to one straight line defined by the points  $(R_{min}, 0)$  and  $(R_{max}, V_{max})$  in the  $(R, V)$  plane. Equation (4-14) can be rearranged to read

$$V_c = \frac{V_{max}}{\beta'} (V_o - \alpha') \quad (4-15)$$

where

$$\alpha' = \alpha + \beta R_{\min} \quad (4-16)$$

$$\beta' = (R_{\max} - R_{\min}) \beta \quad (4-17)$$

Since

$$\alpha = \sum_{i=1}^6 C_i \bar{Q}_i$$

and

$$\beta = \sum_{i=1}^6 D_i \bar{Q}_i$$

it can be written

$$\alpha' = \sum_{i=1}^6 C_i \bar{Q}_i + R_{\min} \sum_{i=1}^6 D_i \bar{Q}_i$$

$$\beta' = (R_{\max} - R_{\min}) \sum_{i=1}^6 D_i \bar{Q}_i$$

New regression coefficients can be defined as

$$C'_i = C_i + R_{\min} D_i \quad (4-18)$$

$$D'_i = (R_{\max} - R_{\min}) D_i \quad (4-19)$$

so that

$$\alpha' = \sum C'_i \bar{Q}_i \quad (4-20)$$

$$\beta' = \sum D'_i Q_i \quad (4-21)$$

These are modified regression coefficients used postiaunch.

It should be noted that the scanner subsystem contains two lamps: primary and secondary. Calibration procedures described are performed for both the lamps. However, during flight operations, the secondary lamp is used only when major problems with the primary lamp are observed.

For bands 1 through 3, commutated samples of video are normally directed to a logarithmic signal compression amplifier and then to the encoder. No signal compression is performed on band 4. A high-gain mode can also be applied to band 1 and 2 voltages before analog-to-digital conversion. Calibration coefficients,  $C'_i$  and  $D'_i$ , are therefore obtained for the low-gain compressed mode for bands 1 through 3, linear quantized mode for band 4, and high-gain compressed mode for bands 1 and 2.

## SECTION 5

### POSTLAUNCH MSS RADIOMETRIC PROCESSING

#### 5.1 INTRODUCTION

Radiometric correction consists of a prelaunch and a postlaunch part. In the prelaunch part, as described in Section 4, the internal calibration lamps are calibrated using an integrating sphere with known radiance values. Regression coefficients ( $C'_1$  and  $D'_1$ ) are derived that are used in computing postlaunch voltage (digital counts) radiance curves. Postlaunch radiometric processing involves determining the video count-radiance curves for each detector using the calibration lamp data either alone or in combination with the scene content data. The final result is a Radiometric Lookup Table (RLUT) that allows a radiance value to be assigned to each detector reading. Computing and applying the RLUT values to produce imagery constitute the MSS radiometric correction.

The steps in the process are shown in Figure 5-1. The detectors are exposed to the internal calibration lamp every other sweep. During each calibration, the internal lamp radiance is modified by a neutral density filter producing a variation from full radiance to zero. At six prechosen calibration wedge word locations, the detector output is sampled. The digital counts combined with prelaunch regression coefficients determine the slope (i.e., gain) and bias (offset) for a linear detector output versus radiance relationship. This calibration is performed for each segment of a scene at a time. Note that at present it has been decided that each MSS scene will be divided into four segments for calibration procedures. The internal calibration could be used directly to produce RLUT's. However, there will be some residual error in the internal calibration procedure that will result in residual striping. An additional calibration, referred to as scene content or histogram calibration, is applied to improve the RLUT's. This scene segment calibration methodology differs from the scan-by-scan calibration scheme used for Landsats 2 and 3.

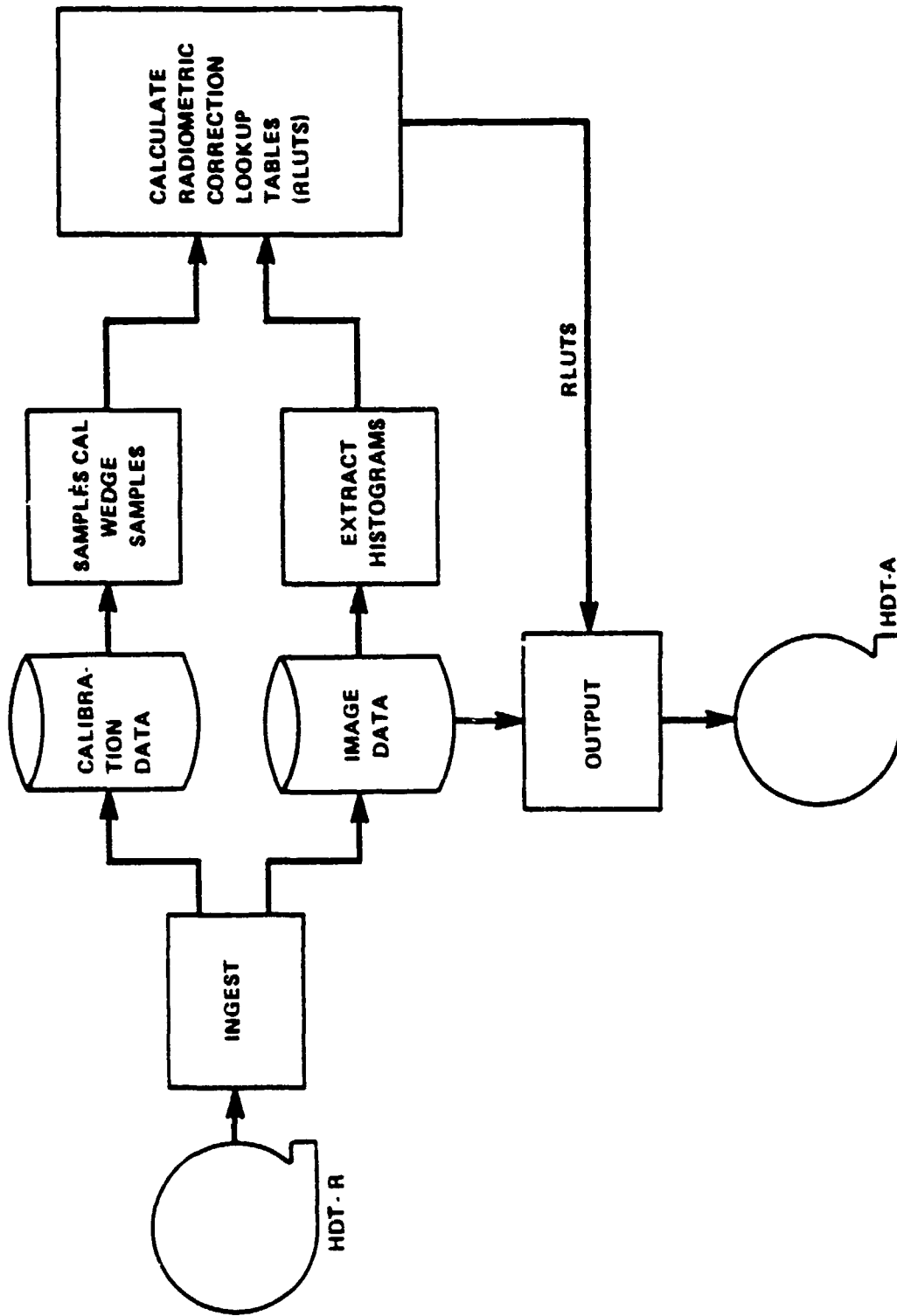

Figure 5-1. Flow Diagram for Postlaunch Radiometric Calibration

## 5.2 RADIOMETRIC CORRECTIONS

During each forward scan of the mirror (in-flight), approximately 3000 6-bit samples are taken from each detector. In every other scan during the retrace part of the mirror, six calibration wedge values (from the internal lamp) for each detector are measured. The detector output for bands 1, 2, and 3 is normally compressed (logarithmically amplified) before sampling. During ground processing, the 6-bit digital samples are decompressed to 7 bits (0 to 127) using decompression tables established during the prelaunch calibration. Band 4 is always 6-bit linear and is expanded to 7 bits for display during ground processing.

Radiometric correction is achieved in two steps: (1) radiometric correction using calibration wedge data only and (2) radiometric correction using scene content.

### 5.2.1 RADIOMETRIC CORRECTION USING CALIBRATION WEDGE DATA

First, the scenes are divided into either one, two, four, or eight (usually four) image segments per scene. For a given segment, each of the six calibration wedge values for each detector is averaged over the segment. Using these average values and the prelaunch linear regression coefficients  $C'_i$  and  $D'_i$ , initial values of the gain  $G$  and offset  $B$  for each detector are calculated:

$$G = \sum_{i=1}^6 D'_i \bar{V}_i \quad (5-1)$$

$$B = \sum_{i=1}^6 C'_i \bar{V}_i \quad (5-2)$$

where  $\bar{V}_i$  is the average value of calibration wedge data. An RLUT that converts output digital samples to estimated radiance samples (for an  $N$ -level display) is then generated:

$$RLUT(i) = (i-1-B)/G \text{ for } 1 \leq i \leq N \quad (5-3)$$

and rounded off to the nearest integer. Here  $N = 127$ . The lookup table must now be truncated for the following reason: It may occur that the detector's saturation output sample value corresponds to a radiance value less than 127. Then, the imagery will appear striped in high-radiance areas. Similarly, it may occur that some detector's zero output sample value may correspond to a radiance value greater than zero. In that case, the imagery will appear striped in low-radiance areas. To avoid this striping, the lookup table must be truncated to display the imagery over a common radiance range. Some residual striping will still remain due to nonlinearities, quantization, hysteresis, or calibration source variation, etc. The lookup table can now be adjusted using scene content on the following assumption: over a "large enough" segment of the imagery, each detector statistically sees the same distribution of radiance.

### 5.2.2 RADIOMETRIC CORRECTION USING SCENE CONTENT

For a given image segment, the observed statistics of a detector's digital output are contained in the sample histogram  $V_h(i, j)$ . This histogram is the number of occurrences of the digital sample  $(i - 1)$  for the  $j$ th detector over the entire image segment. It has been suggested by GE that it is not necessary to use every sample from the detector to generate this histogram. In a test case with Landsat-3 data, GE found that no performance degradation was noted even for histograms generated from as few as every sixteenth sample. This sample reduction for histogram generation has obvious benefits for high-speed processing.

Using the lookup table discussed above (equation (5-3)), an estimated input radiance histogram  $rh(i, j)$  can be generated for each detector in a band. The histograms for the detectors are again truncated to a common radiance range. The next step is to compute an average radiance histogram for a band from the input radiance histograms of the six detectors in the band

$$\bar{rh}(i) = \frac{1}{6} \sum_{j=1}^6 rh(i, j) \quad (5-4)$$



To remove striping, the following algorithm can be used:

- a. Equalization of Average and Standard Deviation—In the following, the indexes  $i$  and  $j$  will be suppressed, remembering that calculations for the new gain and offset refer to an individual detector. Let

$r$  = truncated input radiance histogram for the  $j$ th detector

$z$  = average of the six histograms for a band as defined in equation (5-4)

Now demand that

$$z = g \cdot r + b \quad (5-5)$$

Parameters  $g$  and  $b$  are obtained by equating the mean and standard deviation of both sides of this equation. Therefore,

$$\text{Avg}(z) = \text{Avg}[g \cdot r + b] = g \cdot [\text{Avg}(r)] + b \quad (5-6)$$

$$\text{Var}(z) = \text{Var}[g \cdot r + b] = g^2 \cdot \text{Var}(r) \quad (5-7)$$

or

$$\text{Std}(z) = g \cdot \text{Std}(r) \quad (5-8)$$

so that

$$g = \text{Std}(z) / \text{Std}(r) \quad (5-9)$$

and

$$b = \text{Avg}(z) - g \cdot \text{Avg}(r) \quad (5-10)$$

Here, Avg, Var, and Std refer to average, variance, and standard deviation.

The calculated values of  $g$  and  $b$  can now be used to compute the new gain  $G'$  and offset  $B'$  for the  $j$ th detector. The radiance values  $r$  corresponding to digital outputs from the  $j$ th detector are obtained from

$$r = (V-B)/G \quad (5-11)$$

where  $G$  and  $B$  have been calculated from the calibration wedge data and the regression coefficients  $C'_1$  and  $D'_1$ . Now

$$z = g * r + b = g * [(V-B)/G] + b$$

$$z = (V-B')/G' \quad (5-12)$$

where  $G'$  and  $B'$  are the scene-adjusted gain and offset for the  $j$ th detector given by

$$G' = G/g \quad (5-13)$$

$$B' = B - b * G'$$

With this new gain and offset, the procedure of deriving a lookup table and obtaining truncated, estimated input radiance can be iterated. Because of integer lookup-table roundoff and common radiance range truncation, the average and standard deviations of the updated estimated input radiance histograms do not generally equal that of the original average histogram. The destriping can be improved by iterating (as shown in the schematic diagram of Figure 5-2) the scene content correction.

For illustration purposes, calculation for Avg, Var, and Std for  $r$  will now be shown. Let

$$r = rh(i, j) = \text{truncated estimated input radiance for the } j\text{th detector}$$

Then

$$\text{sum}(j) = \text{number of pixel samples from the } j\text{th detector}$$

INITIAL DIGITAL OUTPUT HISTOGRAM  
FOR EACH DETECTOR

CALCULATE INITIAL GAIN/OFFSET  
FROM CALIBRATION WEDGE DATA

CALCULATE INITIAL INPUT RADIANCE  
HISTOGRAM FOR EACH DETECTOR

AVERAGE OF SIX INPUT RADIANCE  
HISTOGRAMS

SCENE CORRECTED GAIN/OFFSET

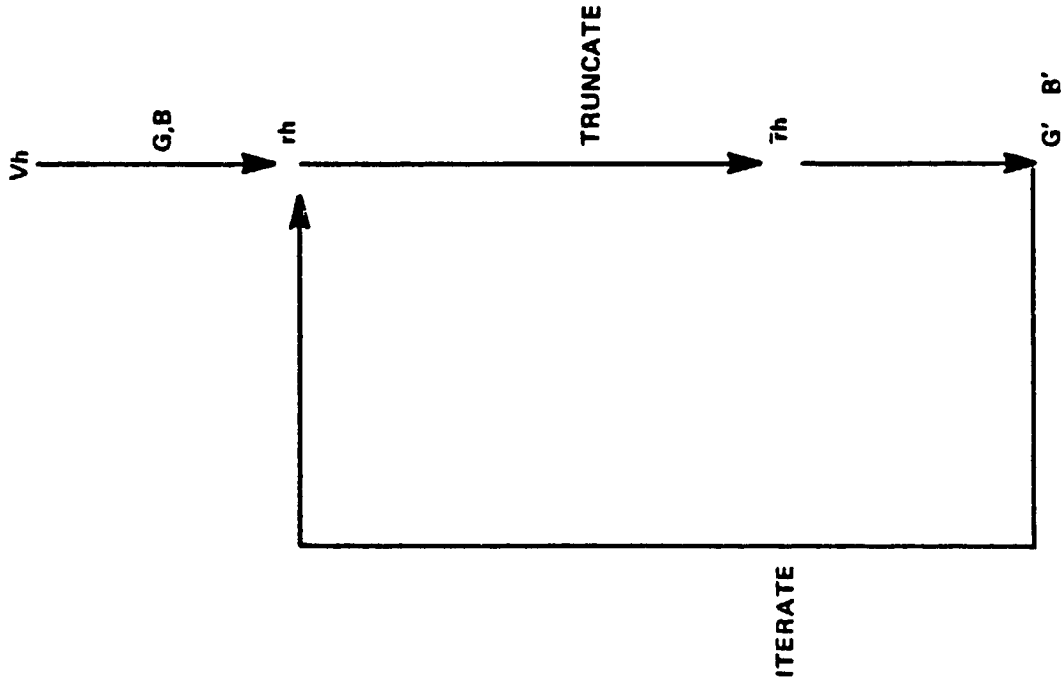

ORIGINAL PAGE IS  
OF POOR QUALITY

Figure 5-2. Flow Diagram of Scene Content Correction Processing

$$\text{sum (j)} = \sum_{i=1}^N \text{rh (i, j)}$$

$$\text{Avg (j)} = \text{Avg (r)} = \sum_{i=1}^N (i - 1) \text{rh (i, j)} / \text{Sum (j)}$$

$$\text{Var (j)} = \text{Var (r)} = \sum_{i=1}^N [i - 1 - \text{Avg (j)}]^2 \text{rh (i, j)} / \text{Sum (j)}$$

$$\text{Std (j)} = \text{Std (r)} = \sqrt{\text{Var (j)}}$$

- b. Image Segment Blending—It has been previously mentioned that each scene is divided into several segments. When viewing the displayed imagery, there should be no evident radiance level discontinuities between segments (i.e., the imagery should blend evenly with those of the adjacent image segments). To blend the imagery from adjacent image segments, each segment is divided into subsegments, and lookup tables for these subsegments are computed by interpolating the gains and offsets between image segments. The interpolation uses a weighted average of the segment gains and biases to compute gains and biases for the boundary subsegments. An example of interpolating gain and bias in the case of three subsegments per processing segment is shown in Figure 5-3.

### 5.3 DETECTOR GAIN AND OFFSET UPDATE

For any given band, the gains and offsets of detectors can have too much of a spread between them. A method is then needed to adjust the calibration equations to achieve reduced striping. The method used introduces multiplicative and additive modifiers (M and A) in the equation for the corrected digital value derived in subsection 4.2. In subsection 4.2, the corrected digital value has been shown to be (equation (4-15))

$$V_c = \frac{V_{\max}}{\beta'} (V_o - \alpha')$$

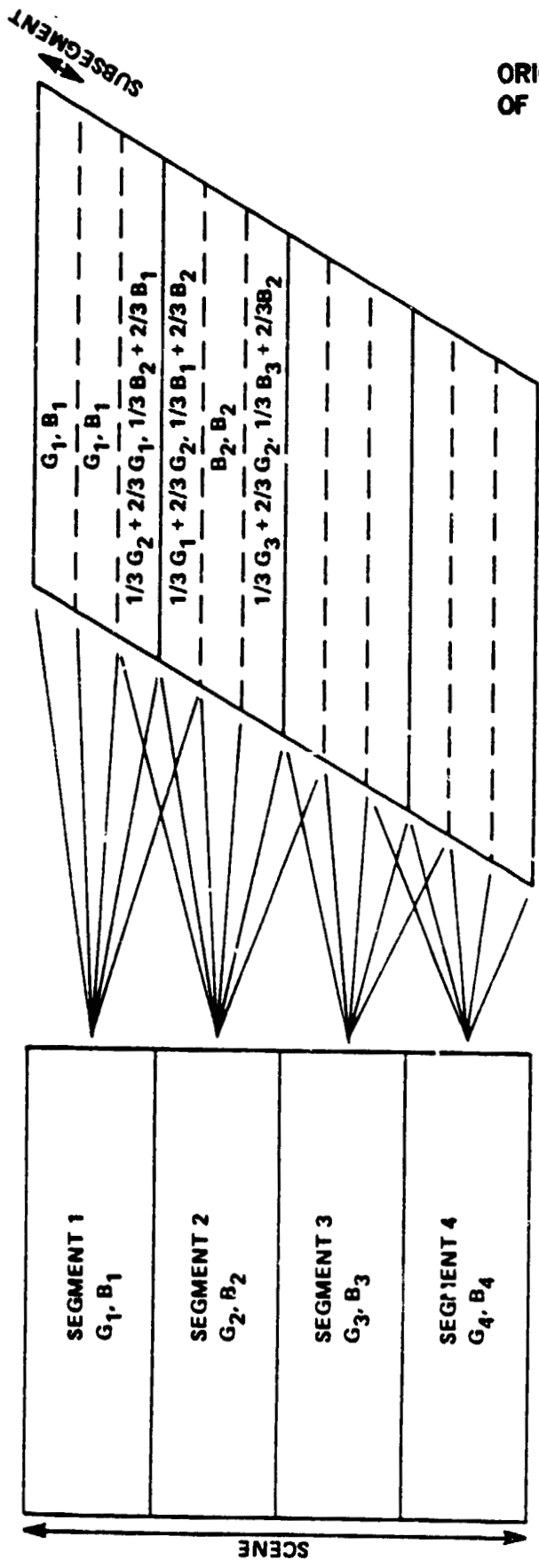

ORIGINAL PAGE IS  
OF POOR QUALITY

EXAMPLE OF SEGMENT BLENDING WITH NUMBER OF SEGMENTS = 4  
NUMBER OF SUBSEGMENTS/SEGMENT = 3

Figure 5-3. Scene Segment Blending

where  $\beta'$  and  $\alpha'$  are gain and offset, and  $V_o$  is the uncorrected digital value.  $V_{max} = 127$ . The modifiers M and A are introduced in the foregoing equation to make it read as

$$V'_c = \frac{V_{max}}{M\beta'} (V_o - \alpha') - A = \frac{V_c}{M} - A \quad (5-14)$$

To find M and A, a detector's mean radiance (over a flat radiance region) is plotted against the band mean radiance for several radiance levels. Linear regression yields a slope  $\mu$  and an offset  $\alpha$  for each detector mean radiance  $(\bar{V}_c)_{det}$  as a function of the band mean radiance  $(\bar{V}_c)_{band}$

$$(\bar{V}_c)_{det} = \mu (\bar{V}_c)_{band} + \alpha \quad (5-15)$$

The goal is to have the detectors in the band calibrated so that they all yield the band mean value when exposed to a flat radiance level. Therefore, the adjusted radiance,  $(\bar{V}_c)'_{det}$ , is given by

$$(\bar{V}_c)'_{det} = (\bar{V}_c)_{band} = \frac{(\bar{V}_c)_{det} - \alpha}{\mu} = \frac{(\bar{V}_c)_{det}}{\mu} - \frac{\alpha}{\mu} \quad (5-16)$$

Comparing this equation with equation (5-14), it can be seen that

$$M = \mu \text{ and } k = \frac{\alpha}{\mu}$$

The calculated values of M and A are stored in a file. By using these modifiers, the corrected digital count for each detector is  $(\bar{V}_c)'_{det}$ . If, at a later time, significant striping occurs, then the M and A for the detector will have to be updated by iterating the above procedure. For this second time,  $(\bar{V}_c)'_{det}$  acts as the old (before correction by M and A)  $(\bar{V}_c)_{det}$ , and it can be written for the second iteration

$$(\bar{V}_c)''_{det} = \frac{(\bar{V}_c)'_{det}}{\mu'} - \frac{\alpha'}{\mu'} \quad (5-17)$$

where  $\mu'$  and  $\alpha'$  are the new slope and offset.  $\mu'$  and  $\alpha'$  can again be determined by regression analysis as before, and the updated  $M'$  and  $A'$  can be shown to be

$$M' = \mu' M$$

$$A' = \frac{A}{\mu'} + \frac{\alpha'}{\mu'}$$

In general, it can be shown that for subsequent iterations

$$M_{i+1} = \mu_{i+1} M_i$$

$$A_{i+1} = \frac{A_i}{\mu_{i+1}} + \frac{\alpha_{i+1}}{\mu_{i+1}}$$

This update is intended as a long-term improvement. In contrast, scene content correction relates only to a specific scene segment. Presumably updating  $M$  and  $A$  will remove detector response changes before the scene content correction.

#### 5.4 $R_{\max}$ AND $R_{\min}$ UPDATE

The modifiers  $M$  and  $A$  can also be used to update the values of  $R_{\max}$  and  $R_{\min}$  discussed in subsection 4.2, equation (4-12). Using modifiers  $M$  and  $A$ , the corrected digital value has been shown to be

$$V'_c = \frac{V_{\max}}{M \beta'} (V_o - \alpha') - A \quad (5-18)$$

If  $R'_{\max}$  and  $R'_{\min}$  are the adjusted cutoff values of the radiances, then analogous to equation (4-12) can be written

$$v'_c = \frac{V_{\max} (R - R'_{\min})}{R'_{\max} - R'_{\min}} \quad (5-19)$$

From equation (4-13),

ORIGINAL PAGE IS  
OF POOR QUALITY

$$R = \frac{V_o - \alpha}{\beta}$$

It should be noted that  $V_o$  is the uncorrected digital count and  $\beta$  and  $\alpha$  are the uncorrected gain and offset. Substituting these in equation (5-19) yields

$$V'_c = \frac{V_{\max} (V_c - \alpha - \beta R'_{\min})}{\beta (R'_{\max} - R'_{\min})} \quad (5-20)$$

Now

$$\begin{aligned} \alpha' &= \alpha + \beta R_{\min} \\ \beta' &= (R_{\max} - R_{\min}) \beta \end{aligned}$$

Substituting for  $\alpha$  and  $\beta$  from this equation in equation (5-20) yields

$$V'_c = \frac{V_{\max} (V_o - \alpha')}{\beta' \left( \frac{R'_{\max} - R'_{\min}}{R_{\max} - R_{\min}} \right)} - V_{\max} \frac{R'_{\min} - R_{\min}}{R'_{\max} - R'_{\min}}$$

Comparing with equation (5-18), it can be written

$$M = \frac{R'_{\max} - R'_{\min}}{R_{\max} - R_{\min}}$$

$$A = V_{\max} \left( \frac{R'_{\min} - R_{\min}}{R'_{\max} - R'_{\min}} \right)$$

Knowing  $M$  and  $A$ ,  $R'_{\max}$  and  $R'_{\min}$  can now be solved. This process can be iterated just as  $M$  and  $A$  are updated through an iterative process.



## SECTION 6

### LANDSAT-4 IMAGE PROCESSING DATA

#### 6.1 IMAGE PROCESSING PARAMETER FILES

Data to be discussed in this section include all parameters used in the MSS Image Processing System (MIPS) and carried in either long- or short-term files. Some of these data are unique to the radiometric response of the sensor. Others are required to gain a more complete understanding of the total MSS image processing scheme used by the Landsat-4 ground data production system.

#### 6.2 SHORT-TERM PARAMETER FILE

The first data set is labeled "Active Detector Status." These data (refer to Table 6-1) carry the nominal calibration values used for MSS radiometry for each sensor. Furthermore, data have been presented for each mode of sensor operation using both the primary calibration lamp (lamp A) and the secondary lamp (lamp B).

Reference to the table can best be illustrated by example. The top row of the table contains six nominal calibration data values for each detector of band 1 when used in the high-gain, linear mode of operation while viewing lamp A. It should be noted, for example, that the numbers can be rearranged as follows:

Detector 1	42	40	38	35	2	2
Detector 2	42	39	38	35	2	2
Detector 3	43	41	39	37	2	2
Detector 4	43	41	38	36	2	2
Detector 5	41	39	37	33	2	2
Detector 6	42	40	38	36	2	2

During radiometric data processing, these tables are referenced. When processing band-1 data in the high-gain, linear mode, the six dynamic calibration values acquired for each of the first band's detectors are compared against this table. If, for example, band 1 sensor 1 has a dynamic calibration response in excess of either of the numbers 42, 40, 38, 35, 2, or 2 by more than six levels.

Table 6-1  
Calibration Nominal Values Used in Each Mode of Sensor Operation

ACTIVE DETECTOR STATUS: AAAAAAAAAAAAAAAAAAAAAA																																				
CAL WEDGE (HIGH GAIN, LINEAR, LAMP A)																																				
42	40	38	35	2	2	42	39	32	35	2	2	43	41	39	37	2	2	43	41	38	36	2	2	41	39	37	33	2	2	42	40	38	35	2	2	
39	36	34	32	2	1	42	39	37	35	2	1	38	35	33	31	2	1	40	37	35	33	2	1	42	39	37	35	2	1	42	39	37	35	2	1	
50	49	46	43	3	3	51	48	46	43	3	3	49	46	44	41	3	3	48	45	43	41	3	3	48	45	43	41	3	3	50	47	45	42	3	3	
55	51	48	45	5	5	52	49	46	43	5	5	52	49	46	43	5	5	52	49	46	43	5	5	48	45	42	40	4	4	48	45	42	40	4	4	
CAL WEDGE (LOW GAIN, LINEAR, LAMP A)																																				
46	44	41	39	2	2	46	44	42	40	2	2	47	45	42	40	2	2	45	43	40	38	2	2	45	43	40	38	2	2	46	44	42	40	2	2	
45	43	41	38	2	2	50	47	44	42	2	2	44	41	39	37	2	2	47	44	42	40	2	2	49	46	44	41	2	2	49	46	44	41	2	2	
50	48	46	43	3	3	51	48	46	43	3	3	52	49	47	45	3	3	49	46	44	41	3	3	43	43	41	3	3	50	47	45	42	3	3		
55	51	48	45	5	5	52	49	46	43	5	5	52	49	46	43	5	5	52	49	46	43	5	5	49	45	42	40	4	4	48	45	42	40	4	4	
CAL WEDGE (HIGH GAIN, COMPRESSED, LAMP A)																																				
47	47	46	45	5	4	47	47	46	44	5	5	50	48	47	45	5	5	50	48	46	45	5	5	48	47	45	43	5	4	49	48	46	45	5	4	
47	45	43	42	4	3	49	47	45	44	4	3	46	44	43	42	4	3	45	44	43	42	4	3	49	46	44	43	5	3	49	47	45	44	5	3	
55	54	52	51	8	7	57	55	54	52	8	8	58	56	54	53	8	8	57	55	53	51	8	8	57	55	53	51	8	7	57	55	53	51	8	7	
55	51	48	45	5	5	52	49	46	43	5	5	52	49	46	43	5	5	52	49	46	43	5	5	48	45	42	40	4	4	48	45	42	40	4	4	
CAL WEDGE (LOW GAIN, COMPRESSED, LAMP A)																																				
53	51	49	47	5	5	52	50	49	47	5	5	54	51	50	48	6	6	54	52	50	48	9	9	54	46	45	43	5	5	51	49	47	46	6	5	
57	55	54	52	6	6	59	57	55	53	7	7	6	55	53	52	50	7	7	56	54	52	50	7	6	56	54	52	50	7	6	56	54	52	51	7	6
55	54	52	51	8	7	57	55	54	52	8	8	58	56	54	53	8	8	57	55	53	51	8	8	57	55	53	51	8	7	57	55	53	51	8	7	
55	51	48	45	5	5	52	49	46	43	5	5	52	49	46	43	5	5	52	49	46	43	5	5	48	45	42	40	4	4	48	45	42	40	4	4	
CAL WEDGE (LOW GAIN, COMPRESSED, LAMP B)																																				
43	41	39	37	2	2	43	40	38	36	3	2	44	41	39	37	3	2	42	40	38	36	2	2	42	40	38	36	2	2	44	41	39	37	3	2	
41	38	37	35	4	3	43	41	39	38	4	4	39	37	35	33	4	4	40	38	36	34	4	4	42	40	38	36	4	4	45	42	41	39	4	4	
49	47	45	42	3	3	49	47	46	43	3	3	52	49	47	44	3	3	48	46	44	41	3	3	47	45	43	40	3	3	49	47	45	42	3	3	
46	44	41	39	4	4	46	44	41	39	4	4	51	49	46	43	4	4	43	45	43	40	4	4	42	39	37	35	4	4	42	40	38	36	4	4	
CAL WEDGE (HIGH GAIN, COMPRESSED, LAMP B)																																				
50	48	47	45	6	5	49	48	46	45	6	6	50	49	47	46	6	6	50	48	47	46	6	6	49	47	46	45	6	6	50	48	47	46	6	6	
48	46	45	44	8	6	50	48	47	46	9	9	47	46	44	43	8	8	46	45	44	43	9	9	49	48	46	45	9	9	51	50	48	47	9	9	
53	52	51	49	7	7	54	52	50	49	7	7	6	56	54	52	50	8	7	53	50	48	47	7	6	53	51	49	48	7	6	54	52	51	49	7	6
46	44	41	39	4	4	46	44	41	39	4	4	51	49	46	43	4	4	48	45	43	40	4	4	42	39	37	35	4	4	42	40	38	36	4	4	
CAL WEDGE (LOW GAIN, COMPRESSED, LAMP B)																																				
53	51	49	48	5	5	53	51	49	48	5	5	54	52	50	49	5	5	53	51	50	48	5	5	52	50	49	47	5	5	53	51	49	48	5	5	
52	50	49	47	6	5	54	52	51	49	6	6	5	50	49	47	45	5	5	51	49	48	46	6	5	51	50	48	46	6	5	53	51	50	48	6	5
54	52	51	49	7	7	54	52	50	49	7	7	6	56	54	52	50	8	7	53	50	48	47	7	6	53	51	49	48	7	6	54	52	51	49	7	6
46	44	41	39	4	4	46	44	41	39	4	4	51	49	46	43	4	4	48	45	43	40	4	4	42	39	37	35	4	4	42	40	38	36	4	4	

the system will default to the nominal value. Using data in this table, the nominal response for every mode of sensor operation can be applied during routine MSS data processing operations.

### 6.3 CALIBRATION MODIFIERS

As the system ages, it is expected that some degradation in apparent sensor response will occur. This can be due either to sensor electronics, variation in output from the calibration lamp, or a combination of factors of this type. The result can be a pronounced video striping effect. Rather than recalibrating with mathematical procedures developed for prelaunch data, NASA has determined, using Landsats 1, 2, and 3, that calibration modifiers for both gain and offset parameters can be derived that significantly reduce visual striping. Before launch, the following relationship is used:

$$[V] = \frac{127}{M\beta'} (V_o - \alpha') - A$$

where

$$M = 1$$

$$A = 0$$

[V] = output digital level

$V_o$  = sensor voltage

$\beta'$  = sensor gain factor

$\alpha'$  = sensor offset factor

Postlaunch studies generate new values of M and A to minimize striping effects. Data of this type are carried in a dated file. The information presented as Table 6-2 was current as of January 25, 1983. At that time, values for M and A in the high-gain mode of operation were not available.



Table 6-3 contains the next data set in the sequence carried in the short-term parameter file. For ease of presentation, these MSS Archive Generation (MAG) records have been merged into a single table. This data set is self-explanatory. Throughout the table, the following acronyms have been used:

ECC	Error Correction Count
CPN	Control Point Neighborhood
CP	Control Point
RLUT	Radiometric Lookup Table
R/C	Radiometric Correction
CC	Cubic Convolution
CPLB	Control Point Library Build
GCP	Geodetic Control Point
MACS	MSS Attitude Correction System
VRS	Vertical Resampling
SOM	Space Oblique Mercator
UTM	Universal Transverse Mercator
PS	Polar Stereographic
S/C	Spacecraft
HRS	Horizontal Resampling

#### **6.4 LONG-TERM PARAMETER FILE**

The long-term parameter file contains five unique records. Table 6-4 contains MIPS parameters relating to repeat performance and data processing required for day-to-day image generation.

Table 6-5 contains decompression tables for radiometry for bands 1, 2, and 3. Using band 1 as an example, Table 6-6 has been constructed from Table 6-5 to illustrate how the 64 multiplexer (mux) levels transmitted to the ground stations are expanded to produce data on the 0 to 127 scale.

ORIGINAL PAGE IS  
OF POOR QUALITY

Table 6-3  
MIPS Parameters Record

```

*****      MAG PARAMETERS RECORD      *****
-----
(ICD RECORD: MAG-PAR1)
INGEST ECC THRESHOLD                2    FRAMES
OUTPUT ECC THRESHOLD                2    FRAMES
INGEST MINOR FRAME SYNCH LOSS THRESHOLD    401
INGEST MISSING SWEEP THRESHOLD        100    SWEEPS
MAXIMUM SUBSTITUTED LINES PER SCENE    2400    LINES
TIME INTERVAL TO COLLECT ECC COUNTS    0.5000000E+01    SECONDS
CPN LINE SIZE                        120    LINES
CPN PIXEL SIZE                       128    PIXELS
MAXIMUM SUBSTITUTED LINES IN CPN        0    LINES
CPN CLOUD COVER LOWER RADIANCE PERCENTAGE 0.0000000E+00
CPN CLOUD COVER UPPER RADIANCE PERCENTAGE 0.0000000E+00
CP CORR. PEAK HEIGHT TO MEAN ACCEPTANCE CRITERIA 0.3000000E+01    SIGMA
CP CORR. SEC. PEAK HEIGHT ACCEPTANCE CRITERIA 0.2000000E+01    SIGMA
CP CORR. SUBPIXEL LOCATION ACCEPTANCE CRITERIA 0.5000000E+00    PIXELS

CP CORR. AT EDGE OF CPN ACCEPTANCE CRITERIA 0.5000000E+01    PIXELS
CP QUICK REG. CP CENTERED IN CPN CRITERIA 0.2000000E+02    PIXELS
CP PREFILTER OUTLIER CRITERIA        0.3000000E+01    SIGMA
FILTER OUTLIER CRITERIA              0.9210000E+01
RLUT SEGMENTS PER SCENE              4
RLUT SUBSEGMENTS PER SCENE           3
R/C HISTOGRAM SWEEP SUBSAMPLE RATIO  0.1000000E+01
R/C HISTOGRAM PIXEL SUBSAMPLE RATIO  0.8000000E+01
MAXIMUM NUMBER OF CAL KEDGE SUBSTITUTIONS 1201
# OF SWEEPS TO INGEST TO ACCOUNT FOR PCS ERROR 4    SWEEPS
MAXIMUM ALLOWABLE LINE LENGTH ERROR   30    PIXELS
HIGH THRESHOLD FOR CC ENHAN. ALGO., BAND 1 0
LOW THRESHOLD FOR CC ENHAN. ALGO., BAND 1 0
HIGH THRESHOLD FOR CC ENHAN. ALGO., BAND 2 0
LOW THRESHOLD FOR CC ENHAN. ALGO., BAND 2 0
HIGH THRESHOLD FOR CC ENHAN. ALGO., BAND 3 0
LOW THRESHOLD FOR CC ENHAN. ALGO., BAND 3 0
HIGH THRESHOLD FOR CC ENHAN. ALGO., BAND 4 0
LOW THRESHOLD FOR CC ENHAN. ALGO., BAND 4 0
HIGH THRESHOLD FOR CC CALC. ALGO., BAND 1 100    QUANTUM LEVELS
LOW THRESHOLD FOR CC CALC. ALGO., BAND 1 20    QUANTUM LEVELS
HIGH THRESHOLD FOR CC CALC. ALGO., BAND 2 100    QUANTUM LEVELS
LOW THRESHOLD FOR CC CALC. ALGO., BAND 2 15    QUANTUM LEVELS
HIGH THRESHOLD FOR CC CALC. ALGO., BAND 3 100    QUANTUM LEVELS
LOW THRESHOLD FOR CC CALC. ALGO., BAND 3 4    QUANTUM LEVELS
HIGH THRESHOLD FOR CC CALC. ALGO., BAND 4 100    QUANTUM LEVELS
LOW THRESHOLD FOR CC CALC. ALGO., BAND 4 4    QUANTUM LEVELS
HIGH THRESHOLD FOR CC REJECTION       0.5000000E+00
X VARIANCE OF CP DISLOCATION           0.4900000E-02    KM**2
Y VARIANCE OF CP DISLOCATION           0.7056000E-02    KM**2

(ICD RECORD: MAG-PAR2)
MEASUREMENT OF NOISE MATRIX ELEMENT 1 0.7280000E-03    KM**2
MEASUREMENT OF NOISE MATRIX ELEMENT 2 0.7280000E-03    KM**2
HIGH THRESHOLD FOR EDGE ENHANCEMENT, BAND 1 100    QUANTUM LEVELS
LOW THRESHOLD FOR EDGE ENHANCEMENT, BAND 1 16    QUANTUM LEVELS
HIGH THRESHOLD FOR EDGE ENHANCEMENT, BAND 2 100    QUANTUM LEVELS
LOW THRESHOLD FOR EDGE ENHANCEMENT, BAND 2 12    QUANTUM LEVELS
HIGH THRESHOLD FOR EDGE ENHANCEMENT, BAND 3 100    QUANTUM LEVELS
LOW THRESHOLD FOR EDGE ENHANCEMENT, BAND 3 3    QUANTUM LEVELS
HIGH THRESHOLD FOR EDGE ENHANCEMENT, BAND 4 100    QUANTUM LEVELS
LOW THRESHOLD FOR EDGE ENHANCEMENT, BAND 4 1    QUANTUM LEVELS
LOW THRESHOLD FOR CHIP & NEIGHBORHOOD CORR. 0.1000000E+01
LOW THRESHOLD NON-SUBS. REAL POINTS IN CORR. 0.0000000E+00
A PRIORI VARIANCE OF PITCH            0.2600000E-05    RAD**2
A PRIORI VARIANCE OF YAW              0.1000000E-05    RAD**2
A PRIORI VARIANCE OF ROLL             0.1200000E-05    RAD**2
RADIAL DISPLACEMENT                  0.1000000E-01    KM**2
PITCH RATE                            0.1000000E-11    (RAD/SEC)**2
ROLL RATE                              0.1000000E-11    (RAD/SEC)**2

```

Table 6-3 (Continued)

***** CP/LN PARAMETERS RECORD *****		
(ICD RECORD: CPLNPARM)		
CPH LINE SIZE	128	LINE
CPH PIXEL SIZE	128	PIXELS
CP LINE SIZE	32	LINE
CP PIXEL SIZE	32	PIXELS
CP ERROR MESSAGE ACCEPTANCE CRITERIA	0.4605000E+01	
CP PEAK HEIGHT ACCEPTANCE CRITERIA	0.5000000E+01	
CP SEC. PEAK HEIGHT ACCEPTANCE CRITERIA	0.2000000E+01	SIGMA
CP DEVIATION ACCEPTANCE CRITERIA	1	SIGMA
CP CORR. SURFACE CURVATURE ACCEPTANCE CRITERIA	0.0000000E+00	
CP SUSPICUL LOCATION ACCEPTANCE CRITERIA	0.3300000E+00	
FILTER OUTLIER CRITERIA	0.9210000E+01	
NUMBER OF GCPs REQUIRED TO GENERATE SCPS	0	
GCD QUALITY ACCEPTANCE CRITERIA	0.3000000E+01	
DIGITIZER CONSISTENCY CRITERIA	0	
VARIANCE OF CP DISLOCATION IN X	0.4900000E-02	KM**2
VARIANCE OF CP DISLOCATION IN Y	0.7056000E-02	KM**2
MEASUREMENT OF NOISE MATRIX ELEMENT 1	0.7290000E-03	KM**2
MEASUREMENT OF NOISE MATRIX ELEMENT 2	0.7280000E-03	KM**2
A PRIORI VARIANCE OF PITCH	0.2600000E-05	RAD**2
A PRIORI VARIANCE OF YAW	0.1000000E-05	RAD**2
A PRIORI VARIANCE OF ROLL	0.1200000E-05	RAD**2
RADIAL DISPLACEMENT	0.1000000E-01	KM**2
PITCH RATE	0.1000000E-11	(RAD/SEC)**2
ROLL RATE	0.1000000E-11	(RAD/SEC)**2
***** PEPG PARAMETERS RECORD *****		
(ICD RECORD: PEPGPARM)		
SIZE OF X RESAMPLING BUFFER	3540	PIXELS
SIZE OF Y RESAMPLING BUFFER	16	LINE
***** S/C AND INSTRUMENT RECORD *****		
(ICD RECORD: S/CINS1)		
NOMINAL PITCH	0.0000000E+00	RADIANS
NOMINAL ROLL	0.0000000E+00	RADIANS
NOMINAL YAW	0.0000000E+00	RADIANS
PITCH ALIGNMENT	0.4702700E-03	RADIANS
ROLL ALIGNMENT	0.2860400E-02	RADIANS
YAW ALIGNMENT	0.5478400E-03	RADIANS
MACS PITCH ALIGNMENT	0.0000000E+00	RADIANS
MACS ROLL ALIGNMENT	0.0000000E+00	RADIANS
MACS YAW ALIGNMENT	0.0000000E+00	RADIANS
# OF X BENCHMARKS (OUTPUT SPACE OR VRS)	61	
# OF Y BENCHMARKS (OUTPUT SPACE OR VRS)	44	
X BENCHMARK SPACING (OUTPUT SPACE OR VRS)	0.6000000E+02	PIXELS
Y BENCHMARK SPACING (OUTPUT SPACE OR VRS)	0.7000000E+02	PIXELS
SCALE FACTOR FOR SGM	0.1000000E+01	
SCALE FACTOR FOR UTM	0.9996000E+00	
SCALE FACTOR FOR PS	0.1000000E+01	
HALF FRAME TIME	0.1468400E+05	MSECS
TIME TO HIOSCAN	0.1600000E+02	MSECS
MOMENT OF INERTIA OF MIRROR	0.9100000E-01	IN*LB*SFC**2
TORSIONAL CONSTANT OF MIRROR	0.2660000E+02	IN*LB/RAD
MSS BAND SEPARATION (BAND 1)	0.0000000E+00	PIXELS
MSS BAND SEPARATION (BAND 2)	0.1950070E+01	PIXELS
MSS BAND SEPARATION (BAND 3)	0.590840E+01	PIXELS
MSS BAND SEPARATION (BAND 4)	0.5040910E+01	PIXELS
NOMINAL S/C VELOCITY	0.7500000E+01	KM/SECS
NOMINAL GROUND VELOCITY	0.6750000E+01	KM/SECS
(ICD RECORD: S/CINS2)		
# OF INPUT PIXELS BETWEEN ALONG SCAN BENCHMARKS	0.9100000E+02	PIXELS
# OF INPUT LINES BETWEEN ALONG TRACK BENCHMARKS	0.4000000E+02	LINE
# OF OUTPUT PIXELS BETWEEN X BENCHMARKS	0.5000000E+02	PIXELS
# OF OUTPUT LINES BETWEEN VERTICAL BENCHMARKS	0.7000000E+02	LINE
OUTPUT PIXEL SIZE	0.5700000E-01	KM
ACTIVE SCAN TIME	0.1230000E-01	SECONDS

Table 6-3 (Continued)

NOMINAL TIME BETWEEN SWEEP STARTS	0.7342000E-01	SECONDS
MIDSCAN INPUT PIXEL VALUE	0.1620500E+04	
% OF BURIED PIXELS TO LEFT OF IMAGE FRAME	0.0000000E+00	PIXELS
OUTPUT PIXEL NUMBER FOR RIGHT BURIED	0.3548000E+04	PIXELS
INPUT PIXEL LOC. OF THE LEFT OVERLAP MARKS	-0.2000000E+02	
INPUT PIXEL LOC. OF THE RIGHT OVERLAP MARKS	0.3260000E+04	
INPUT LINE NUMBER OF LOWER OVERLAP MARKS	0.2197000E+04	
INPUT LINE NUMBER OF UPPER OVERLAP MARKS	0.2030000E+03	
% OF OUTPUT LINES ABOVE THE IMAGE FRAME	0.0000000E+00	LINES
% OF LAST LINE OF THE FRAME	0.2983000E+04	
MAXIMUM ABSOLUTE VALUE OF HRS J DIFFERENCE	0.1200000E+00	
MAXIMUM ABSOLUTE VALUE OF HRS-X DIFFERENCE	0.1100000E+01	
MAXIMUM ABSOLUTE VALUE OF VRS-Y DIFFERENCE	0.7600000E+00	
MAXIMUM ABSOLUTE VALUE OF VRS-X DIFFERENCE	0.1200000E-01	
MEAN VALUE OF HRS J DIFFERENCE	0.4800000E+02	
MEAN VALUE OF HRS X DIFFERENCE	0.6000000E+02	
MEAN VALUE OF VRS Y DIFFERENCE	0.7000000E+02	
MEAN VALUE OF VRS X DIFFERENCE	0.6000000E+02	
COORDINATE OF SCENE CENTER IN HRS GRID	0.3055000E+02	
COORDINATE OF SCENE CENTER IN VRS GRID	0.2230000E+02	
TIME BETWEEN PIXELS	0.9958000E-05	SECONDS
TIME BETWEEN S/C EPHEMERIS POINTS	0.2048000E+01	SECONDS
TIME BETWEEN S/C ATTITUDE POINTS	0.5120000E+00	SECONDS
NO. OF SWEEPS PRIOR TO SC. CENTER IN USEFUL DATA	184	
NOMINAL SCAN LINE AT SCENE CENTER (NADIRLINE)	0.1203500E+04	
(ICD RECORD: S/CLENS)		
NOMINAL PIXELS PER INPUT LINE	3240	PIXELS
% OF INPUT LINES IN PARTIALLY PROCESSED IMAGE	2400	LINES
NOMINAL SCALE OF INPUT INTER-PIXEL DISTANCE	0.5700000E+02	METERS
NOMINAL SCALE OF INPUT INTER-LINE DISTANCE	0.9270000E+02	METERS
% OF PIXELS/OUTPUT LINE OF FULLY PROCESSED IMAGE	3548	PIXELS
% OF LINES PER FULLY PROCESSED IMAGE	2983	LINES
SCALE OF FULLY PROCESSED INTER-PIXEL DISTANCE	0.5700000E+02	METERS
SCALE OF FULLY PROCESSED INTER-LINE DISTANCE	0.5700000E+02	METERS
NOMINAL SPACECRAFT ALTITUDE	0.7053000E+06	METERS
NOMINAL INPUT SWATH WIDTH	105000	METERS
NSS MIRROR MODEL COEFFICIENT A0	0.2333900E+00	
NSS MIRROR MODEL COEFFICIENT A1	0.1749900E+02	RAD/SECS
NSS MIRROR MODEL COEFFICIENT A2	-0.1615000E+02	MSECS
NSS MIRROR MODEL COEFFICIENT A3	0.9958000E-02	MSECS
NSS MAXIMUM MIRROR ANGLE	0.1299000E+00	RADIANS
SCAN SKEW CONSTANT	0.1351350E-02	RADIANS
TIME BETWEEN SUCCESSIVE SWEEPS	0.7342000E-01	SECONDS
TIME FOR ACTIVE PORTION OF MIRROR SWEEP	0.3230000E-01	SECONDS
SEMI-MAJOR AXIS OF EARTH (INT. SPHEROID)	0.6378388E+04	KMS
SEMI-MINOR AXIS OF EARTH (INT. SPHEROID)	0.6356912E+04	KMS
EARTH CURVATURE CONSTANT	-0.1113315E-12	
(ICD RECORD: SDBO)		
NSS SAMPLING DELAYS FOR DETECTORS 1 THRU 24 (PIXELS):		
	-0.2720005E+01 -0.2800665E+01 -0.2800525E+01 -0.2960305E+01 -0.3040245E+01 -0.3120105E+01	
	-0.2720005E+01 -0.2800665E+01 -0.2800525E+01 -0.2960305E+01 -0.3040245E+01 -0.3120105E+01	
	-0.2720005E+01 -0.2800665E+01 -0.2800525E+01 -0.2960305E+01 -0.3040245E+01 -0.3120105E+01	
	-0.2720005E+01 -0.2800665E+01 -0.2800525E+01 -0.2960305E+01 -0.3040245E+01 -0.3120105E+01	
NSS BAND TO BAND OFFSET FOR BAND 2 (REL. TO 1)	0.1950070E+01	PIXELS
NSS BAND TO BAND OFFSET FOR BAND 3 (REL. TO 1)	0.3890040E+01	PIXELS
NSS BAND TO BAND OFFSET FOR BAND 4 (REL. TO 1)	0.5840910E+01	PIXELS



Table 6-4  
Additional MIPS Parameters

MIPS LONG TERM PARAMETER FILE MIPS\_PARMS;HL4005.AM  
25-JAN-1983 14:12:06.00

```
*****  
IC#8 MIPS LONGTERM PARAMETER RECORD LONGTERMS000  
LONGTERMH4000  
IR#4 EARTH ROTATION BETWEEN ASCENDING NODES (ARC-MIN)  
1487.320  
IR#4 ORBIT REPEAT CYCLE (DAYS)  
16.00000  
IR#4 ORBITS PER CYCLE  
233.0000  
IR#4 SATELLITE PERIOD (MINUTES)  
98.08412  
IR#4 INCLINATION OF ORBIT (DEGREES)  
98.20000  
IR#4 ECCENTRICITY OF EARTH ELIPSOID  
8.1992000E-02  
IR#4 ORBIT RADIUS (METERS)  
7003465.  
IR#4 LONGITUDE OF ASCENDING NODE PRIOR TO PATH 1  
127.7605  
IC#2 TYPE OF SUPEROID  
.54  
IR#4 EARTH RADIUS AT EQUATOR (KMS)  
6378.388  
IR#4 WRS SPACING AT THE EQUATOR (DEGREES)  
1.545064  
II#4 NUMBER OF PATHS IN THE WRS  
233  
II#4 NUMBER OF ROWS IN THE WRS  
248  
II#4 NUMBER OF ROWS IN THE DELTA EPHEMERIS  
16  
II#4 NUMBER OF COLUMNS IN THE DELTA EPHEMERIS  
3  
II#4 NUMBER OF ROWS IN THE DELTA ATTITUDE  
64  
II#4 NUMBER OF COLUMNS IN THE DELTA ATTITUDE  
3  
IR#4 MIDDLE LINE NUMBER OF INPUT NOMINAL SCENE  
1203.500  
IR#4 MIDDLE PIXEL NUMBER OF INPUT NOMINAL SCENE  
1620.500  
II#4 NUMBER OF COLUMNS IN THE HRS  
61  
II#4 NUMBER OF ROWS IN THE HRS  
51  
II#4 NUMBER OF COLUMNS IN THE VRS  
61  
II#4 NUMBER OF ROWS IN THE VRS  
44
```

ORIGINAL PAGE IS  
OF POOR QUALITY

ORIGINAL PAGE IS  
OF POOR QUALITY

Table 6-5  
Decompression Tables for Bands 1, 2, and 3

DETINORC4000

11\*4 NOMINAL CAL WEDGE WINDOW SIZE

6

11\*4 DECOMPRESSION TABLES FOR BANDS 1 AND 3. 64 VALUES

0	1	2	3	3	4
5	6	7	8	9	10
11	12	13	14	16	17
18	20	21	22	24	26
27	29	31	33	34	36
38	40	42	44	46	48
50	52	54	56	59	62
65	67	70	73	76	79
82	85	88	91	94	96
99	102	105	108	111	114
117	120	123	127		

11\*4 DECOMPRESSION TABLE FOR BAND 2. 64 VALUES

0	1	2	2	3	4
5	6	7	8	9	10
11	12	13	14	16	17
18	19	21	22	24	26
27	29	31	33	34	36
38	40	42	44	46	48
49	51	54	56	59	62
64	67	70	73	76	79
81	84	87	90	93	96
99	102	105	108	111	114
117	120	123	127		

ORIGINAL PAGE IS  
OF POOR QUALITY

Table 6-6  
Decompressed Digital Values

Original	Decompressed	Original	Decompressed
0	0	32	42
1	1	33	44
2	2	34	46
3	3	35	48
4	3	36	50
5	4	37	52
6	5	38	54
7	6	39	56
8	7	40	59
9	8	41	62
10	9	42	65
11	10	43	67
12	11	44	70
13	12	45	73
14	13	46	76
15	14	47	79
16	16	48	82
17	17	49	85
18	18	50	88
19	20	51	91
20	21	52	94
21	22	53	96
22	24	54	99
23	26	55	102
24	27	56	105
25	29	57	108
26	31	58	111
27	33	59	114
28	34	60	117
29	36	61	120
30	38	62	123
31	40	63	127

The third record of importance (Table 6-7) is the set of  $C_i$  and  $D_i$  values calculated using pre-launch data. These values are presented for each sensor in each mode of operation. The sequence of values for each calibration lamp source follows the same pattern given in Table 6-1, in which the calibration response has been presented in terms of digital counts. This set of  $C_i$ ,  $D_i$  is used to calculate sensor gain and offset in terms of radiance and calibration wedge digital response. These data are presented in Tables 6-7, 6-8, 6-9, and 6-10. The fourth record contains calibration wedge offsets for each sensor in the high- and low-gain modes of operation. These data presented in Tables 6-11 and 6-12 can be correlated directly with calibration wedge response. Therefore, the following applies for sensor 1, band 1, and high gain:

Word	460	470	480	490	910	920
Calibration Response	42	40	38	35	2	2

where the calibration response refers to the calibration wedge described in Table 6-1.

Finally, Table 6-13 contains data used in image generation relating to tic-mark placement and separation and to the size of the annotation words used by MIPS.

ORIGINAL PAGE IS  
OF POOR QUALITY

Table 6-7  
Calibration Coefficients for High-Gain, Prime Lamp

\*\*\*\*\*  
IC#12 CALIBRATION RECORD KEY  
CALICORP4000  
\*\*\*\*\*

LAMP A (PRIME)	OFFSETS (CI)	AND GAINS (DI)	OFFSETS (CI)	AND GAINS (DI)	FOR SIX CAL WEDGE VALUES
HIGH GAIN	OFFSETS (CI)	AND GAINS (DI)	OFFSETS (CI)	AND GAINS (DI)	FOR SIX CAL WEDGE VALUES
DETECTOR 1	OFFSETS: -0.5034660E-01	GAINS: 0.4393915	OFFSETS: 1.9569900E-02	GAINS: 0.3634670E-01	0.5090237
DETECTOR 2	OFFSETS: -0.4696410E-01	GAINS: 0.4455089	OFFSETS: 0.3180776	GAINS: 0.2638616	-0.6931777
DETECTOR 3	OFFSETS: -0.4951040E-01	GAINS: 0.4415793	OFFSETS: 0.1402540E-01	GAINS: 0.3933630E-01	0.5010356
DETECTOR 4	OFFSETS: -0.4833200E-01	GAINS: 0.4504787	OFFSETS: 0.3186053	GAINS: 0.2657756	-0.5995937
DETECTOR 5	OFFSETS: -0.4712620E-01	GAINS: 0.4419056	OFFSETS: 0.9761000E-01	GAINS: 0.3898490E-01	0.5141420
DETECTOR 6	OFFSETS: -0.4818700E-01	GAINS: 0.4475909	OFFSETS: 0.3205073	GAINS: 0.2606126	-0.7077797
DETECTOR 7	OFFSETS: -0.4918100E-01	GAINS: 0.4471573	OFFSETS: 0.1167500E-01	GAINS: 0.3826920E-01	0.5120857
DETECTOR 8	OFFSETS: -0.4786690E-01	GAINS: 0.4577151	OFFSETS: 0.3242962	GAINS: 0.2686916	-0.7227359
DETECTOR 9	OFFSETS: -0.4764340E-01	GAINS: 0.4620484	OFFSETS: 0.1305000E-01	GAINS: 0.3843440E-01	0.5103938
DETECTOR 10	OFFSETS: -0.4595430E-01	GAINS: 0.457220	OFFSETS: 0.3166170	GAINS: 0.2643114	-0.7084656
DETECTOR 11	OFFSETS: -0.4825250E-01	GAINS: 0.4394034	OFFSETS: 0.1234110E-01	GAINS: 0.3968850E-01	0.5110331
DETECTOR 12	OFFSETS: -0.4411100E-01	GAINS: 0.4394034	OFFSETS: 0.3214320	GAINS: 0.2614054	-0.7175566
OFFFTOW 17	OFFSETS: -0.4411100E-01	GAINS: 0.4394034	OFFSETS: 0.2319700E-01	GAINS: 0.5041100E-01	0.4987552
			OFFSETS: 0.2722290E-01	GAINS: 0.2406223	-0.6850487
			OFFSETS: 0.2953363	GAINS: 0.2466412	0.4514411
			OFFSETS: 0.2722290E-01	GAINS: 0.4969290E-01	-0.6710020
			OFFSETS: 0.3020510E-01	GAINS: 0.2466412	-0.6717733
			OFFSETS: 0.2925267	GAINS: 0.5721700E-01	0.4851587
			OFFSETS: 0.2572020E-01	GAINS: 0.2359710	-0.6656624
			OFFSETS: 0.3007519	GAINS: 0.5119340E-01	0.3933990
			OFFSETS: 0.2359710	GAINS: 0.2464138	-0.5912141
			OFFSETS: 0.2435528	GAINS: 0.4753515E-01	0.4994534
			OFFSETS: 0.2627794	GAINS: 0.2435528	-0.6803529
			OFFSETS: 0.2114110E-01	GAINS: 0.4747740E-01	0.4910113

Table 6-7 (Continued)

DETECTOR 13	OFFSETS	GAINS	0.4532148	0.3720921	0.3070097	0.2514836	-0.5843521	-0.6994466
			-0.5704220E-01	-0.2197540E-01	0.8423000E-02	0.3760200E-01	0.5132497	-0.5177433
DETECTOR 14	OFFSETS	GAINS	0.4055327	0.3419547	0.2859595	0.2303389	-0.0282730	-0.6374206
			-0.5796030E-01	-0.2231510E-01	0.8275200E-02	0.3914750E-01	0.5141711	0.5135357
DETECTOR 15	OFFSETS	GAINS	0.4074523	0.3427029	0.2872969	0.2312959	-0.6303183	-0.5395099
			-0.5926110E-01	-0.2706710E-01	0.4115500E-02	0.3753270E-01	0.5200683	0.5246107
DETECTOR 16	OFFSETS	GAINS	0.4143347	0.3552930	0.2901065	0.2360220	-0.6401126	-0.6264431
			-0.6022640E-01	-0.2476510E-01	0.7526200E-02	0.3026340E-01	0.5173103	0.5215927
DETECTOR 17	OFFSETS	GAINS	0.4272965	0.3605108	0.2955936	0.2418133	-0.6603417	-0.6399715
			-0.5673130E-01	-0.2233320E-01	0.8034400E-02	0.3040070E-01	0.5149243	0.5156952
DETECTOR 18	OFFSETS	GAINS	0.4306794	0.3611317	0.2931255	0.2450689	-0.6654352	-0.6745509
			-0.5866450E-01	-0.2347670E-01	0.8640600E-02	0.3974310E-01	0.5149391	0.5155175
DETECTOR 19	OFFSETS	GAINS	0.4225129	0.3555332	0.2959356	0.2392554	-0.6530377	-0.6318102
			-0.8750200E-01	-0.4144450E-01	-0.3951700E-02	0.3990730E-01	0.5467716	0.5122212
DETECTOR 20	OFFSETS	GAINS	0.4161379	0.3300703	0.2771546	0.2059172	-0.6174682	-0.6198230
			-0.8913090E-01	-0.4259440E-01	-0.2070100E-02	0.3871050E-01	0.5463895	0.5175871
DETECTOR 21	OFFSETS	GAINS	0.4322807	0.3536371	0.2951537	0.2160676	-0.6417043	-0.6524320
			-0.8681630E-01	-0.3995520E-01	0.1126500E-02	0.3991670E-01	0.5437302	0.5452751
DETECTOR 22	OFFSETS	GAINS	0.4152705	0.3417387	0.2751145	0.2112865	-0.6236233	-0.6261835
			-0.8829550E-01	-0.4554920E-01	0.2753300E-02	0.4064930E-01	0.5171393	0.5481322
DETECTOR 23	OFFSETS	GAINS	0.4370450	0.3727785	0.2976214	0.2213627	-0.6683377	-0.6712754
			-0.8513990E-01	-0.4298810E-01	0.728000E-03	0.3921280E-01	0.5441099	0.5455178
DETECTOR 24	OFFSETS	GAINS	0.4754781	0.3958842	0.3161137	0.2406665	-0.7127149	-0.7154302
			-0.8418970E-01	-0.4236670E-01	-0.3245000E-03	0.3645530E-01	0.5442715	0.5461547
			0.4599492	0.3812669	0.3061812	0.2307447	-0.6923353	-0.6957924

Table 6-8  
Calibration Coefficients for Low-Gain, Primary Lamp

LOW GAIN	OFFSETS (CI)	AND GAINS (CI)	FOR SIX CAL WEDGE VALUES			
DETECTOR 1	OFFSETS: -0.5064050E-01	-0.2074160E-01	0.8467600E-02	0.3403190E-01	0.5137314	0.5149513
	GAINS: 0.4066399	0.3510130	0.2963050	0.2484233	-0.6500403	-0.6522336
DETECTOR 2	OFFSETS: -0.4096130E-01	-0.1239700E-01	0.7747000E-02	0.3455340E-01	0.5137392	-0.5135980
	GAINS: 0.4174407	0.3601867	0.3076617	0.2958161	-0.6692752	-0.6719299
DETECTOR 3	OFFSETS: -0.4889510E-01	-0.1909270E-01	0.7016700E-02	0.3260320E-01	0.5135559	0.150127
	GAINS: 0.4003154	0.3510636	0.3024074	0.2543204	-0.6577334	-0.6593334
DETECTOR 4	OFFSETS: -0.4896064E-01	-0.1941010E-01	0.7305000E-02	0.3308160E-01	0.5131428	0.5148501
	GAINS: 0.4205451	0.3629122	0.3109079	0.2605745	-0.6137452	-0.6150941
DETECTOR 5	OFFSETS: -0.4755000E-01	-0.2222070E-01	0.9532700E-02	0.3461060E-01	0.5126950	0.5147114
	GAINS: 0.4177801	0.3645877	0.3035175	0.2547755	-0.6605032	-0.6725572
DETECTOR 6	OFFSETS: -0.4573960E-01	-0.1838200E-01	0.7951100E-02	0.3240670E-01	0.5132293	0.5149755
	GAINS: 0.4202252	0.3603066	0.3081800	0.2605552	-0.6129570	-0.6152297
DETECTOR 7	OFFSETS: -0.5564900E-01	-0.1940160E-01	0.1120500E-01	0.4251390E-01	0.5066771	0.5118601
	GAINS: 0.3761566	0.3151057	0.2622203	0.2102347	-0.5791196	-0.5845259
DETECTOR 8	OFFSETS: -0.5443910E-01	-0.1916970E-01	0.1063320E-01	0.3967680E-01	0.5090675	0.5131305
	GAINS: 0.3760300	0.3167271	0.2659329	0.2164330	-0.5892922	-0.5910016
DETECTOR 9	OFFSETS: -0.5335200E-01	-0.1817020E-01	0.1165700E-01	0.3866120E-01	0.5090674	0.5121167
	GAINS: 0.3711513	0.3160415	0.2657101	0.2194242	-0.5659658	-0.5671633
DETECTOR 10	OFFSETS: -0.5441640E-01	-0.1823660E-01	0.1291340E-01	0.4020700E-01	0.5102355	0.5108255
	GAINS: 0.3877621	0.3217904	0.2675044	0.2190160	-0.5940566	-0.5950623
DETECTOR 11	OFFSETS: -0.5380600E-01	-0.1977140E-01	0.1027140E-01	0.4085980E-01	0.5097633	0.5123768
	GAINS: 0.3896601	0.3126268	0.2622496	0.2109577	-0.5746152	-0.5760767
DETECTOR 12	OFFSETS: -0.5412300E-01	-0.1990290E-01	0.9926100E-02	0.1152150E-01	0.5094231	0.5131574
	GAINS: 0.3507511	0.3217345	0.2702051	0.2158096	-0.5910753	-0.5927448
DETECTOR 13	OFFSETS: -0.5704220E-01	-0.2197540E-01	0.8423000E-02	0.3960700E-01	0.5132497	0.5177433
	GAINS: 0.4055327	0.3419647	0.2860505	0.2303389	-0.6227250	-0.6254208
DETECTOR 14	OFFSETS: -0.5796030E-01	-0.2231510E-01	0.2725200E-02	0.3914950E-01	0.5181711	0.5183057
	GAINS: 0.4074523	0.3427028	0.2022949	0.2312958	-0.6303182	-0.6335009
DETECTOR 15	OFFSETS: -0.5926110E-01	-0.2706710E-01	0.4115500E-02	0.3753370E-01	0.5200683	0.5246107
	GAINS: 0.4143347	0.3552930	0.2901066	0.2368220	-0.6481126	-0.6534421
DETECTOR 16	OFFSETS: -0.6022040E-01	-0.2476540E-01	0.7526400E-02	0.3826340E-01	0.5173103	0.5218927
	GAINS: 0.4272965	0.3605108	0.2996896	0.2418133	-0.6603447	-0.6629745
DETECTOR 17	OFFSETS: -0.5873330E-01	-0.2233320E-01	0.8034000E-02	0.3840070E-01	0.5149241	0.5186452
	GAINS: 0.4306794	0.3611317	0.3031056	0.2450589	-0.6654352	-0.6743509
DETECTOR 18	OFFSETS: -0.5566450E-01	-0.2347670E-01	0.8040600E-02	0.3874310E-01	0.5149391	0.5196175
	GAINS: 0.4251129	0.3565332	0.2959356	0.2390664	-0.6530377	-0.6610102
DETECTOR 19	OFFSETS: -0.6050200E-01	-0.4144460E-01	-0.3951700E-02	0.3907300E-01	0.5407716	0.562212
	GAINS: 0.4161379	0.3800704	0.2771048	0.2052172	-0.6174502	-0.6193230
DETECTOR 20	OFFSETS: -0.6120900E-01	-0.4239400E-01	-0.2070100E-02	0.3601950E-01	0.5403856	0.5639971
	GAINS: 0.412007	0.3576371	0.2851537	0.2160676	-0.6417043	-0.6454350
DETECTOR 21	OFFSETS: -0.6063630E-01	-0.3995920E-01	0.1126500E-02	0.3891670E-01	0.5437302	0.5432751
	GAINS: 0.4192705	0.3417307	0.2775145	0.2112065	-0.6251835	-0.6251835
DETECTOR 22	OFFSETS: -0.6528550E-01	-0.4554920E-01	-0.2763300E-02	0.4054930E-01	0.5471193	0.5682122
	GAINS: 0.4570490	0.3727796	0.2976214	0.2213527	-0.6533377	-0.671277
DETECTOR 23	OFFSETS: -0.6513990E-01	-0.4202810E-01	-0.1428000E-03	0.3224200E-01	0.5131099	0.5353173
	GAINS: 0.4254731	0.3250642	0.3161137	0.2405565	-0.7127147	-0.7151302
DETECTOR 24	OFFSETS: -0.8110970E-01	-0.4325670E-01	-0.3240000E-03	0.3575530E-01	0.5142715	0.531547
	GAINS: 0.4599492	0.3332669	0.3061012	0.2310747	-0.6923463	-0.6957911

Table 6-9  
Calibration Coefficients for High-Gain, Redundant Lamp

LAMP B (REDUNDANT)	OFFSETS (CI) AND GAINS (DI)	OFFSETS (CI) AND GAINS (DI) FOR SIX CAL WEDGE VALUES	OFFSETS (CI) AND GAINS (DI) FOR SIX CAL WEDGE VALUES	OFFSETS (CI) AND GAINS (DI) FOR SIX CAL WEDGE VALUES	OFFSETS (CI) AND GAINS (DI) FOR SIX CAL WEDGE VALUES
DETECTOR 1	OFFSETS: -0.5383770E-01	OFFSETS: -0.2314010E-01	OFFSETS: 0.6396000E-02	OFFSETS: 0.3447040E-01	OFFSETS: 0.5192770
	GAINS: 0.4306146	GAINS: 0.3706659	GAINS: 0.3120100	GAINS: 0.2581455	GAINS: -0.6907873
DETECTOR 2	OFFSETS: -0.5131310E-01	OFFSETS: -0.2134540E-01	OFFSETS: 0.5593100E-02	OFFSETS: 0.3570250E-01	OFFSETS: 0.5111365
	GAINS: 0.4441472	GAINS: 0.3230537	GAINS: 0.3230537	GAINS: 0.2665262	GAINS: -0.7010643
DETECTOR 3	OFFSETS: -0.5204050E-01	OFFSETS: -0.2251720E-01	OFFSETS: 0.4413260E-02	OFFSETS: 0.3522700E-01	OFFSETS: 0.5161733
	GAINS: 0.4359769	GAINS: 0.3331154	GAINS: 0.3714310	GAINS: 0.2816950	GAINS: -0.6927177
DETECTOR 4	OFFSETS: -0.551120E-01	OFFSETS: -0.2453140E-01	OFFSETS: 0.5236970E-02	OFFSETS: 0.3561150E-01	OFFSETS: 0.5164109
	GAINS: 0.4524313	GAINS: 0.3098941	GAINS: 0.3277441	GAINS: 0.2672845	GAINS: -0.7132953
DETECTOR 5	OFFSETS: -0.5234610E-01	OFFSETS: -0.2212430E-01	OFFSETS: 0.9521360E-02	OFFSETS: 0.3583130E-01	OFFSETS: -0.7271094
	GAINS: 0.4387608	GAINS: 0.3702271	GAINS: 0.3148327	GAINS: 0.2341215	GAINS: 0.5172654
DETECTOR 6	OFFSETS: -0.5273760E-01	OFFSETS: -0.2246360E-01	OFFSETS: 0.6722200E-02	OFFSETS: 0.3697290E-01	OFFSETS: -0.7021066
	GAINS: 0.4451463	GAINS: 0.3757324	GAINS: 0.3252283	GAINS: 0.2631319	GAINS: 0.5150539
DETECTOR 7	OFFSETS: -0.6073620E-01	OFFSETS: -0.2271010E-01	OFFSETS: 0.3033300E-02	OFFSETS: 0.2605410E-01	OFFSETS: -0.7115233
	GAINS: 0.4205013	GAINS: 0.3507163	GAINS: 0.3063931	GAINS: 0.2555113	GAINS: 0.5220745
DETECTOR 8	OFFSETS: -0.5987640E-01	OFFSETS: -0.2461550E-01	OFFSETS: 0.5089000E-02	OFFSETS: 0.3174230E-01	OFFSETS: -0.6811422
	GAINS: 0.4360113	GAINS: 0.3698337	GAINS: 0.3166708	GAINS: 0.26083706	GAINS: 0.5248264
DETECTOR 9	OFFSETS: -0.5640410E-01	OFFSETS: -0.2536150E-01	OFFSETS: 0.4757900E-02	OFFSETS: 0.3321290E-01	OFFSETS: -0.6724639
	GAINS: 0.4360635	GAINS: 0.3763007	GAINS: 0.3166708	GAINS: 0.25308781	OFFSETS: -0.6905159
DETECTOR 10	OFFSETS: -0.5142460E-01	OFFSETS: -0.2156940E-01	OFFSETS: 0.4683000E-02	OFFSETS: 0.2953910E-01	OFFSETS: 0.5237499
	GAINS: 0.4236624	GAINS: 0.3548735	GAINS: 0.3221315	GAINS: 0.2357467	OFFSETS: -0.6521114
DETECTOR 11	OFFSETS: -0.650530E-01	OFFSETS: -0.2730500E-01	OFFSETS: 0.6757000E-02	OFFSETS: 0.2320630E-01	OFFSETS: 0.5222849
	GAINS: 0.4247166	GAINS: 0.3560025	GAINS: 0.3027507	GAINS: 0.2625574	OFFSETS: -0.6710319
DETECTOR 12	OFFSETS: -0.630260E-01	OFFSETS: -0.2749200E-01	OFFSETS: 0.3275500E-02	OFFSETS: 0.273510E-01	OFFSETS: 0.5290809
	GAINS: 0.4304259	GAINS: 0.3630409	GAINS: 0.3031791	GAINS: 0.2508057	OFFSETS: -0.5307084
DETECTOR 13	OFFSETS: -0.5633750E-01	OFFSETS: -0.2146400E-01	OFFSETS: 0.9054400E-02	OFFSETS: 0.3290220E-01	OFFSETS: -0.6821756
	GAINS: 0.4018272	GAINS: 0.3398092	GAINS: 0.2334907	GAINS: 0.2294948	OFFSETS: 0.5153595
DETECTOR 14	OFFSETS: -0.553590E-01	OFFSETS: -0.2301500E-01	OFFSETS: 0.9313500E-02	OFFSETS: 0.3359700E-01	OFFSETS: -0.6305326
	GAINS: 0.4106207	GAINS: 0.3301585	GAINS: 0.2204791	GAINS: 0.2364209	OFFSETS: 0.5137771
DETECTOR 15	OFFSETS: -0.5909790E-01	OFFSETS: -0.2957550E-01	OFFSETS: 0.2980555	OFFSETS: 0.2164209	OFFSETS: -0.6467015
	GAINS: 0.4111196	GAINS: 0.3573509	GAINS: 0.2980555	GAINS: 0.3609760E-01	OFFSETS: 0.5235132
DETECTOR 16	OFFSETS: -0.5090450E-01	OFFSETS: -0.236540E-01	OFFSETS: 0.8523700E-02	OFFSETS: 0.3377676	OFFSETS: -0.6469506
	GAINS: 0.4195379	GAINS: 0.353035	GAINS: 0.2941260	GAINS: 0.2430482	OFFSETS: 0.5172916
DETECTOR 17	OFFSETS: -0.5729180E-01	OFFSETS: -0.2311620E-01	OFFSETS: 0.1103720E-01	OFFSETS: 0.3752870E-01	OFFSETS: -0.6521128
	GAINS: 0.4250326	GAINS: 0.3502161	GAINS: 0.2953913	GAINS: 0.2449197	OFFSETS: 0.5140637
DETECTOR 18	OFFSETS: -0.574090E-01	OFFSETS: -0.2100710E-01	OFFSETS: 0.9675000E-02	OFFSETS: 0.3329170E-01	OFFSETS: -0.6533733
	GAINS: 0.4148569	GAINS: 0.3462704	GAINS: 0.2908130	GAINS: 0.2375407	OFFSETS: 0.5130556
DETECTOR 19	OFFSETS: -0.7647870E-01	OFFSETS: -0.3624200E-01	OFFSETS: -0.1703500E-02	OFFSETS: 0.3293920E-01	OFFSETS: -0.642772
	GAINS: 0.4564912	GAINS: 0.3978004	GAINS: 0.3715975	OFFSETS: 0.2655075	OFFSETS: 0.5307743
DETECTOR 20	OFFSETS: -0.7675450E-01	OFFSETS: -0.3723760E-01	OFFSETS: -0.2221800E-02	OFFSETS: 0.3220370E-01	OFFSETS: -0.7182616
	GAINS: 0.4657200	GAINS: 0.3802111	GAINS: 0.3277444	OFFSETS: 0.2571024	OFFSETS: 0.5109377
DETECTOR 21	OFFSETS: -0.7632510E-01	OFFSETS: -0.3855000E-01	OFFSETS: -0.1967000E-02	OFFSETS: 0.3442040E-01	OFFSETS: -0.7160620
	GAINS: 0.4501274	GAINS: 0.3532604	GAINS: 0.2905015	GAINS: 0.2314037	OFFSETS: 0.5198450
DETECTOR 22	OFFSETS: -0.7956350E-01	OFFSETS: -0.3651690E-01	OFFSETS: -0.3831400E-02	OFFSETS: 0.3920200E-01	OFFSETS: -0.6605740
	GAINS: 0.4613162	GAINS: 0.3862625	GAINS: 0.3213909	GAINS: 0.2572255	OFFSETS: 0.5452149
DETECTOR 23	OFFSETS: -0.7550100E-01	OFFSETS: -0.3835500E-01	OFFSETS: -0.4270600E-02	OFFSETS: 0.3437560E-01	OFFSETS: -0.7135038
	GAINS: 0.5070500	GAINS: 0.4291974	GAINS: 0.3577580	OFFSETS: 0.2760829	OFFSETS: 0.5443123
DETECTOR 24	OFFSETS: -0.7505930E-01	OFFSETS: -0.3921310E-01	OFFSETS: -0.3815400E-02	OFFSETS: 0.3335480E-01	OFFSETS: -0.7302412
	GAINS: 0.5010801	GAINS: 0.4247016	GAINS: 0.3534581	OFFSETS: 0.2765091	OFFSETS: 0.5174337
					OFFSETS: -0.7212181



ORIGINAL PAGE IS  
OF POOR QUALITY

Table 6-10  
Calibration Coefficients for Low-Gain, Redundant Lamp

LOW GAIN	OFFSETS (CI)	AND GAINS (DI)	FOR SIX CAL WEDGE VALUES			
DETECTOR 1	OFFSETS1	-0.5037410E-01	-0.1260890E-01	0.7132600E-02	0.3375370E-01	0.5132428
	GAINS1	0.3294784	0.3410130	0.2716339	0.2446260	-0.6100542
DETECTOR 2	OFFSETS1	-0.4975510E-01	-0.1735030E-01	0.7233600E-02	0.3218100E-01	-0.5122950
	GAINS1	0.4147490	0.3358850	0.2663102	0.2563242	-0.6640353
DETECTOR 3	OFFSETS1	-0.5137230E-01	-0.1975050E-01	0.9005600E-02	0.3239350E-01	0.5151455
	GAINS1	0.4072016	0.3491500	0.2929401	0.2507528	-0.6554353
DETECTOR 4	OFFSETS1	-0.4935090E-01	-0.1605950E-01	0.7552100E-02	0.3247900E-01	0.5133566
	GAINS1	0.4140422	0.3563326	0.3053348	0.2576932	-0.6637852
DETECTOR 5	OFFSETS1	-0.5100600E-01	-0.1601540E-01	0.7085500E-02	0.3480700E-01	0.5122984
	GAINS1	0.4120724	0.3511910	0.3005527	0.2498238	-0.6590336
DETECTOR 6	OFFSETS1	-0.4957900E-01	-0.1917420E-01	0.7952200E-02	0.3223100E-01	0.5134971
	GAINS1	0.4107260	0.3525094	0.1952200E-02	0.2553845	-0.6502282
DETECTOR 7	OFFSETS1	-0.5335520E-01	-0.2134540E-01	0.1028900E-01	0.4057520E-01	0.5102282
	GAINS1	0.3722590	0.3180521	0.2545379	0.2113024	-0.5811059
DETECTOR 8	OFFSETS1	-0.5284440E-01	-0.2093220E-01	0.2033300E-02	0.3220700E-01	0.5103325
	GAINS1	0.3760710	0.3210000	0.2702823	0.2230214	-0.5050040
DETECTOR 9	OFFSETS1	-0.5230090E-01	-0.1501950E-01	0.1151540E-01	0.3571700E-01	0.5103121
	GAINS1	0.3720433	0.3212748	0.2677050	0.2242520	-0.5930197
DETECTOR 10	OFFSETS1	-0.5711350E-01	-0.2110650E-01	0.1653200E-01	0.4231610E-01	0.6090710
	GAINS1	0.3762354	0.3220329	0.2678903	0.2137770	-0.5072270
DETECTOR 11	OFFSETS1	-0.5363690E-01	-0.2252900E-01	0.0717800E-02	0.3932520E-01	0.5122315
	GAINS1	0.3509101	0.3099493	0.2537572	0.2035159	-0.5651125
DETECTOR 12	OFFSETS1	-0.5340150E-01	-0.2176900E-01	0.9007620E-02	0.3923230E-01	0.5113117
	GAINS1	0.3569290	0.3111073	0.2620717	0.2127253	-0.5715930
DETECTOR 13	OFFSETS1	-0.5333750E-01	-0.2146100E-01	0.2054400E-02	0.3930020E-01	0.5128416
	GAINS1	0.4010272	0.3309092	0.2639987	0.2294340	-0.6237667
DETECTOR 14	OFFSETS1	-0.5565300E-01	-0.2301500E-01	0.9113500E-02	0.3059700E-01	0.5137771
	GAINS1	0.4104307	0.3501595	0.2904791	0.2364209	-0.6407773
DETECTOR 15	OFFSETS1	-0.5909700E-01	-0.2957550E-01	0.2990700E-02	0.3507100E-01	0.5230323
	GAINS1	0.41111	0.3573509	0.2900555	0.2377676	-0.6435056
DETECTOR 16	OFFSETS1	-0.5090300E-01	-0.2355640E-01	0.0523200E-02	0.3596600E-01	0.5122936
	GAINS1	0.4196329	0.3520035	0.2911210	0.2130468	-0.6521139
DETECTOR 17	OFFSETS1	-0.5723180E-01	-0.2311620E-01	0.1103720E-01	0.3762370E-01	0.5140537
	GAINS1	0.4250026	0.3502161	0.2953913	0.2449197	-0.6593733
DETECTOR 18	OFFSETS1	-0.5713090E-01	-0.2163710E-01	0.9675900E-02	0.3829170E-01	0.5132956
	GAINS1	0.4140550	0.3466704	0.2806130	0.2376407	-0.6427722
DETECTOR 19	OFFSETS1	-0.7643070E-01	-0.3534200E-01	0.1703300E-02	0.3239200E-01	0.5396150
	GAINS1	0.4617912	0.3079004	0.3216975	0.2550735	-0.7132332
DETECTOR 20	OFFSETS1	-0.7615450E-01	-0.3728760E-01	-0.2027100E-02	0.3223370E-01	0.5373777
	GAINS1	0.4657200	0.3902111	0.3227129	0.2571054	-0.7180160
DETECTOR 21	OFFSETS1	-0.7632510E-01	-0.3895000E-01	0.1967000E-02	0.3442040E-01	0.5396150
	GAINS1	0.4301274	0.3632604	0.2985036	0.2340937	-0.6605740
DETECTOR 22	OFFSETS1	-0.7265350E-01	-0.3051690E-01	-0.3031400E-02	0.3020800E-01	0.5132149
	GAINS1	0.4643362	0.3869675	0.3213909	0.2522265	-0.7115558
DETECTOR 23	OFFSETS1	-0.7552100E-01	-0.4276000E-01	-0.4276000E-02	0.3437560E-01	0.5137320
	GAINS1	0.5070303	0.4291074	0.3577490	0.2768029	-0.7500732
DETECTOR 24	OFFSETS1	-0.7505920E-01	-0.3824300E-01	-0.3824300E-02	0.3136240E-01	0.5134312
	GAINS1	0.5010801	0.4247016	0.3534459	0.2153091	-0.7316182

ORIGINAL PAGE IS  
OF POOR QUALITY

Table 6-11  
Calibration Wedge Offsets for the Prime Lamp

LAMP A (PRIME)		CAL WEDGE OFFSETS						
HIGH GAIN		CAL WEDGE OFFSETS FOR SIX CAL WEDGE VALUES						
DETECTOR 1	CAL WEDGE OFFSETS:	460	470	480	490	910	920	
DETECTOR 2	CAL WEDGE OFFSETS:	463	473	483	493	913	923	
DETECTOR 3	CAL WEDGE OFFSETS:	467	477	487	497	917	927	
DETECTOR 4	CAL WEDGE OFFSETS:	471	481	491	501	921	931	
DETECTOR 5	CAL WEDGE OFFSETS:	475	485	495	505	925	935	
DETECTOR 6	CAL WEDGE OFFSETS:	479	489	499	509	929	939	
DETECTOR 7	CAL WEDGE OFFSETS:	568	578	588	598	938	948	
DETECTOR 8	CAL WEDGE OFFSETS:	571	581	591	601	941	951	
DETECTOR 9	CAL WEDGE OFFSETS:	575	585	595	605	945	955	
DETECTOR 10	CAL WEDGE OFFSETS:	579	589	599	609	949	959	
DETECTOR 11	CAL WEDGE OFFSETS:	583	593	603	613	953	963	
DETECTOR 12	CAL WEDGE OFFSETS:	587	597	607	617	957	967	
DETECTOR 13	CAL WEDGE OFFSETS:	370	380	390	400	880	890	
DETECTOR 14	CAL WEDGE OFFSETS:	373	383	393	403	883	893	
DETECTOR 15	CAL WEDGE OFFSETS:	377	387	397	407	887	897	
DETECTOR 16	CAL WEDGE OFFSETS:	381	391	401	411	891	901	
DETECTOR 17	CAL WEDGE OFFSETS:	385	395	405	415	895	905	
DETECTOR 18	CAL WEDGE OFFSETS:	389	399	409	419	899	909	
DETECTOR 19	CAL WEDGE OFFSETS:	323	333	343	353	743	753	
DETECTOR 20	CAL WEDGE OFFSETS:	327	337	347	357	747	757	
DETECTOR 21	CAL WEDGE OFFSETS:	331	341	351	361	751	761	
DETECTOR 22	CAL WEDGE OFFSETS:	335	345	355	365	755	765	
DETECTOR 23	CAL WEDGE OFFSETS:	340	350	360	370	760	770	
DETECTOR 24	CAL WEDGE OFFSETS:	344	354	364	374	764	774	
LOW GAIN		CAL WEDGE OFFSETS FOR SIX CAL WEDGE VALUES						
DETECTOR 1	CAL WEDGE OFFSETS:	220	230	240	250	800	810	
DETECTOR 2	CAL WEDGE OFFSETS:	224	234	244	254	804	814	
DETECTOR 3	CAL WEDGE OFFSETS:	227	237	247	257	807	817	
DETECTOR 4	CAL WEDGE OFFSETS:	232	242	252	262	812	822	
DETECTOR 5	CAL WEDGE OFFSETS:	235	245	255	265	815	825	
DETECTOR 6	CAL WEDGE OFFSETS:	239	249	259	269	819	829	
DETECTOR 7	CAL WEDGE OFFSETS:	327	337	347	357	867	877	
DETECTOR 8	CAL WEDGE OFFSETS:	330	340	350	360	870	880	
DETECTOR 9	CAL WEDGE OFFSETS:	334	344	354	364	874	884	
DETECTOR 10	CAL WEDGE OFFSETS:	338	348	358	368	878	888	
DETECTOR 11	CAL WEDGE OFFSETS:	342	352	362	372	882	892	
DETECTOR 12	CAL WEDGE OFFSETS:	346	356	366	376	886	896	
DETECTOR 13	CAL WEDGE OFFSETS:	365	375	385	395	875	885	
DETECTOR 14	CAL WEDGE OFFSETS:	369	379	389	399	879	889	
DETECTOR 15	CAL WEDGE OFFSETS:	373	383	393	403	883	893	
DETECTOR 16	CAL WEDGE OFFSETS:	377	387	397	407	887	897	
DETECTOR 17	CAL WEDGE OFFSETS:	380	390	400	410	890	900	
DETECTOR 18	CAL WEDGE OFFSETS:	384	394	404	414	894	904	
DETECTOR 19	CAL WEDGE OFFSETS:	319	329	339	349	739	749	
DETECTOR 20	CAL WEDGE OFFSETS:	323	333	343	353	743	753	
DETECTOR 21	CAL WEDGE OFFSETS:	327	337	347	357	747	757	
DETECTOR 22	CAL WEDGE OFFSETS:	331	341	351	361	751	761	
DETECTOR 23	CAL WEDGE OFFSETS:	335	345	355	365	755	765	
DETECTOR 24	CAL WEDGE OFFSETS:	339	349	359	369	759	769	

ORIGINAL PAGE IS  
OF POOR QUALITY

Table 6-12  
Calibration Wedge Offsets for the Redundant Lamp

LAMP B (REDUNDANT) CAL WEDGE OFFSETS							
HIGH GAIN		CAL WEDGE OFFSETS FOR SIX CAL WEDGE VALUES					
DETECTOR 1	CAL WEDGE OFFSETS:	460	470	480	490	910	920
DETECTOR 2	CAL WEDGE OFFSETS:	463	473	483	493	913	923
DETECTOR 3	CAL WEDGE OFFSETS:	467	477	487	497	917	927
DETECTOR 4	CAL WEDGE OFFSETS:	471	481	491	501	921	931
DETECTOR 5	CAL WEDGE OFFSETS:	475	485	495	505	925	935
DETECTOR 6	CAL WEDGE OFFSETS:	479	489	499	509	929	939
DETECTOR 7	CAL WEDGE OFFSETS:	568	578	588	598	938	948
DETECTOR 8	CAL WEDGE OFFSETS:	572	582	592	602	942	952
DETECTOR 9	CAL WEDGE OFFSETS:	576	586	596	606	946	956
DETECTOR 10	CAL WEDGE OFFSETS:	579	589	599	609	949	959
DETECTOR 11	CAL WEDGE OFFSETS:	583	593	603	613	953	963
DETECTOR 12	CAL WEDGE OFFSETS:	587	597	607	617	957	967
DETECTOR 13	CAL WEDGE OFFSETS:	370	380	390	400	880	890
DETECTOR 14	CAL WEDGE OFFSETS:	374	384	394	404	884	894
DETECTOR 15	CAL WEDGE OFFSETS:	378	388	398	408	888	898
DETECTOR 16	CAL WEDGE OFFSETS:	382	392	402	412	892	902
DETECTOR 17	CAL WEDGE OFFSETS:	385	395	405	415	895	905
DETECTOR 18	CAL WEDGE OFFSETS:	389	399	409	419	899	909
DETECTOR 19	CAL WEDGE OFFSETS:	322	332	342	352	742	752
DETECTOR 20	CAL WEDGE OFFSETS:	326	336	346	356	746	756
DETECTOR 21	CAL WEDGE OFFSETS:	330	340	350	360	750	760
DETECTOR 22	CAL WEDGE OFFSETS:	333	343	353	363	753	763
DETECTOR 23	CAL WEDGE OFFSETS:	338	348	358	368	758	768
DETECTOR 24	CAL WEDGE OFFSETS:	342	352	362	372	762	772
LOW GAIN		CAL WEDGE OFFSETS FOR SIX CAL WEDGE VALUES					
DETECTOR 1	CAL WEDGE OFFSETS:	220	230	240	250	800	810
DETECTOR 2	CAL WEDGE OFFSETS:	224	234	244	254	804	814
DETECTOR 3	CAL WEDGE OFFSETS:	227	237	247	257	807	817
DETECTOR 4	CAL WEDGE OFFSETS:	231	241	251	261	811	821
DETECTOR 5	CAL WEDGE OFFSETS:	235	245	255	265	815	825
DETECTOR 6	CAL WEDGE OFFSETS:	239	249	259	269	819	829
DETECTOR 7	CAL WEDGE OFFSETS:	327	337	347	357	667	677
DETECTOR 8	CAL WEDGE OFFSETS:	331	341	351	361	671	681
DETECTOR 9	CAL WEDGE OFFSETS:	334	344	354	364	674	684
DETECTOR 10	CAL WEDGE OFFSETS:	338	348	358	368	678	688
DETECTOR 11	CAL WEDGE OFFSETS:	342	352	362	372	682	692
DETECTOR 12	CAL WEDGE OFFSETS:	346	356	366	376	686	696
DETECTOR 13	CAL WEDGE OFFSETS:	366	376	386	396	676	686
DETECTOR 14	CAL WEDGE OFFSETS:	370	380	390	400	680	690
DETECTOR 15	CAL WEDGE OFFSETS:	373	383	393	403	683	693
DETECTOR 16	CAL WEDGE OFFSETS:	377	387	397	407	687	697
DETECTOR 17	CAL WEDGE OFFSETS:	381	391	401	411	691	701
DETECTOR 18	CAL WEDGE OFFSETS:	385	395	405	415	695	705
DETECTOR 19	CAL WEDGE OFFSETS:	318	328	338	348	738	748
DETECTOR 20	CAL WEDGE OFFSETS:	322	332	342	352	742	752
DETECTOR 21	CAL WEDGE OFFSETS:	325	335	345	355	745	755
DETECTOR 22	CAL WEDGE OFFSETS:	329	339	349	359	749	759
DETECTOR 23	CAL WEDGE OFFSETS:	334	344	354	364	754	764
DETECTOR 24	CAL WEDGE OFFSETS:	338	348	358	368	758	768

ORIGINAL PAGE IS  
OF POOR QUALITY

Table 6-13  
Geometric Image Tic-Mark and Annotation Parameters  
Carried in the Long-Term Record

```
*****  
IC#12 POLAR STEREOGRAPHIC TICKMARK RECORD KEY  
PSTCKMRK4000  
IR#4 HORIZONTAL PIXEL SIZE (METERS)  
57.00000  
IR#4 VERTICAL PIXEL SIZE (METERS)  
57.00000  
D  II#4 TICKMARK SEPARATION (KMS)  
  
50  
II#4 LENGTH OF HORIZONTAL ANNOTATION BLOCK (PIXELS)  
336  
II#4 LENGTH OF VERTICAL ANNOTATION BLOCK (LINES)  
420  
II#4 PIXELS PER OUTPUT LINE (PIXELS)  
3548  
II#4 LINES IN THE OUTPUT IMAGE (LINES)  
2983  
II#4 DISTANCE IN PIXELS AWAY FROM THE X AXIS OF THE PS SYSTEM  
1492  
IR#4 WINDOW SIZE AROUND 0.0 FOR P(1,1) AND P(1,2)  
9.9999998E-03  
IR#4 WINDOW SIZE AROUND 0.90,180,-90 (DEGREES)  
0.1745000
```